

Standalone Transmitter

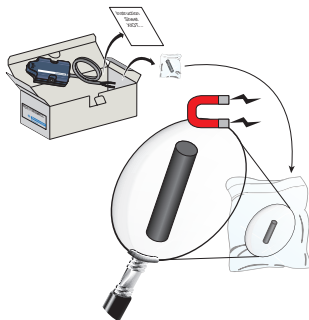

<http://qr.tesensors.com/XIOT001>

Flash this Qr-code to access this Instruction Sheet in other languages.

Note: you can download this Instruction Sheet in different languages from our website at: www.tesensors.com

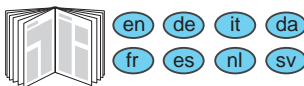

We welcome your comments about this document. You can reach us by e-mail at: customer-support@tesensors.com

NOTICE

UNINTENDED EQUIPMENT OPERATION

The transmission must not exceed 50 frames / day and 6 frames / hour. Exceeding these limits leads to a service break (stop transfer of data to the user).

⚠ WARNING

IMPROPER UTILIZATION

The XIOT11SE●●● is operated on a radio network which can be perturbed by external sources. In addition, a permanent access to data and services through internet is dependent to third party operators and cannot be ensured at 100%. Therefore the system must not be used for critical alerts.

Failure to follow these instructions can result in death, serious injury, or equipment damage.

Note:

- The good operating of the data transmission between the **XIOT11SE●●●** transmitter and the application depends of the Sigfox network performances.
- For an application, owned to a customer working directly with Sigfox® but using a **XIOT11SE●●●** transmitter, see the Sigfox® contract terms about cybersecurity.
- Telemecanique Sensors cannot guarantee the live coverage of the Sigfox® network and future deployment. To ensure reliable operation of the system, it is important to check that the XIOT Transmitter will be installed in an area with a good level of signal. For more information please contact your nearest distributor. A theoretical network coverage is also available on the Sigfox® website, from the smartphone application **XIOT App**. and from the XIOT Platform: <https://XIOT.Tesensors.com>

Product Presentation

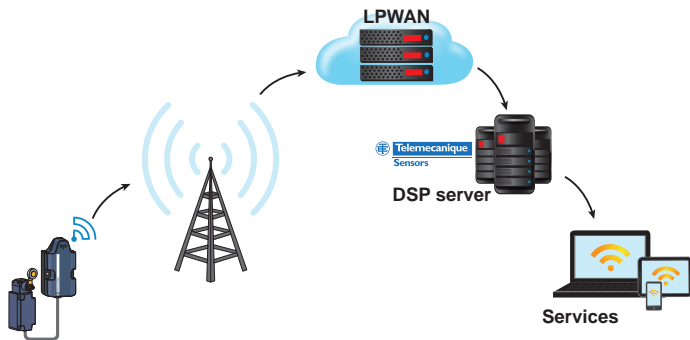

The **XIOT11SE●●●** standalone transmitter allows to exploit state changes of one or two dry contacts through a **LPWAN** connection (radio type). The transmitted information is made available on the web via a web browser or from IOS and Android mobile applications.
The data is also accessible by owner applications for specific treatments.

Integrated Services:

- 5-year subscription to the «Sigfox®» network (Only for the ref. **XIOT11SE5MRCL**)
- Hosting data on Schneider-Electric servers
- Web access for setting and treatment of transmitted data
- Android and IOS applications for real-time diagnostics and alerts
- Information on the state of the internal battery
- Information on the quality of radio reception by the «Sigfox®» network

 Electrical equipment should be installed, operated, serviced, and maintained only by qualified personnel. No responsibility is assumed by Schneider Electric for any consequences arising out of the use of this material.

© 2018 Schneider Electric. "All Rights Reserved."

Dimensions

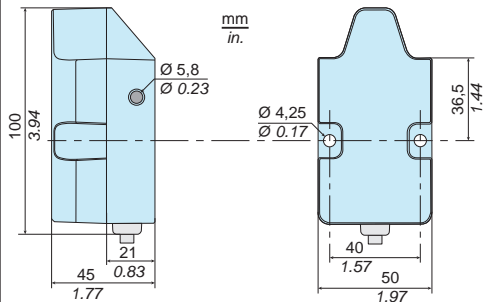

Mounting

By screws:

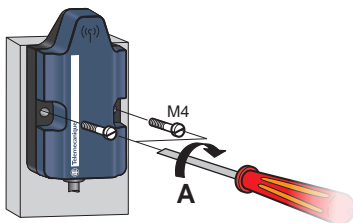

A: 3 N.m / 26.6 lb-in

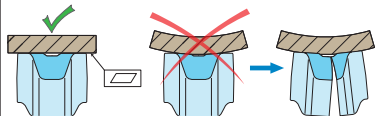
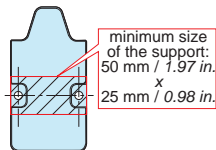

Wiring precaution

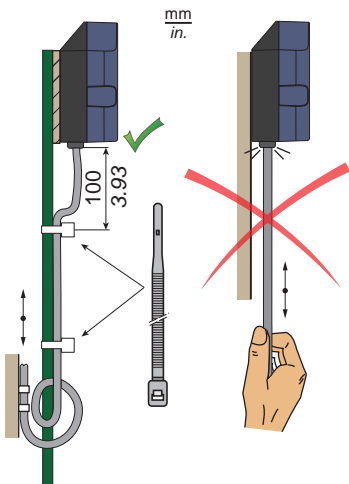

Note:

The cable extension, beyond a 3 meters length, requires installation precautions, in case of electrical equipment presence, nearby. Move the cable away from equipment generating electromagnetic interference (transformer, power supply line, electric welding, etc.).

Mounting tips

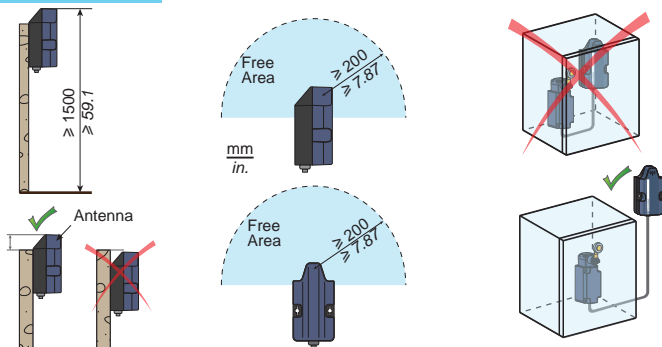

Signal attenuation according to the material

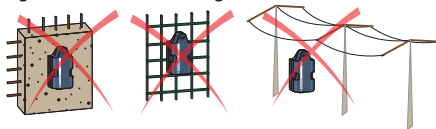

(*): Values for indication purposes only. Actual values depend on the thickness and nature of the material.

Material	Signal attenuation (%)	Material attenuation (db)
Glass window	10...20% (*)	2
Plaster wall	20...30% (*)	3
Brick wall	50% (*)	6
Concrete wall	70...80% (*)	15
Metal structure	70...100% (*)	30
High voltage grid	50...90% (*)	20

Wiring diagrams

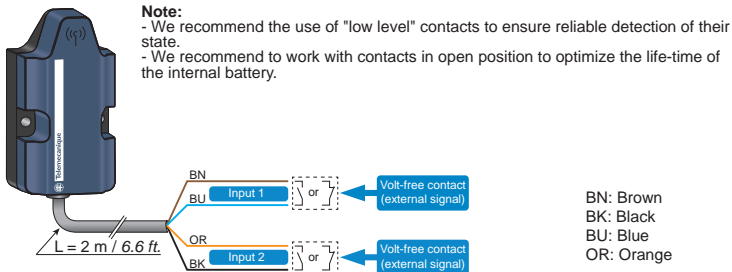

Characteristics

Power Supply	Type	Integrated lithium battery (Saft LS14500)	
	Voltage	3,6 V---	
	Lifetime	Number of frames / day	Integrated battery lifetime
		20	2,3 years
		10	4,2 years
2	13,6 years		
		Note: - These calculations are done for a temperature of 20 °C. - Product storage before use: ≤ 1 year	
Input	Type	2 low level volt-free contact type inputs	
	Contact input	3 V - 6 µA	
	Detection level	To detect an OPEN state: > 1.7 V	
		To detect an CLOSED state: < 0.7 V	
Debounce time (filter)	100 ms		
Compatibility	Limit switches	XCM - XCK M/L/S - XCKJ - XCKN - XCK P/T/D	
	Pressure switches	XML A/B/C/D	
Connection	Type	Cable (length: 2 m) - 2 x 2 wires: 0,34 mm ² / AWG 22	
Fixing		Screw (2 x M4)	
Dimensions (mm / in.)		50 x 45 x100 / 1.97 x 1.77 x 3.94	
Weight (g / lb.)		215 / 0.47	
Receiving network cover		See the map on the Sigfox [®] website: https://www.sigfox.com/en/coverage Or see the map on XIOT Platform: https://XIOT.Tesensors.com [Sigfox [®] coverage]	
Transmission	Sending	On state change of inputs + 1 keep alive frame / day	
	Frames	Sigfox [®] Europe format - 12 bytes - 100 bps	
	Activation	By external magnet (delivered with the transmitter)	
	Operating frequency band	868,00 ... 868,60 MHz (sub-band h1.4 from annex 1 of ERC/REC 70-03)	
	Maximum effective radiated power	≤ 25 mW (14 dBm) according to EN/ETSI 300220-2	
Product certifications		EU, SIGFOX ready	
Regulations		EU according to 2014/53/EU	
Standards		EN 62368-1 / EN 301489-1 / EN 300220-2	
Ambient air temperature	Storage	- 25 ... + 70 °C / - 13 ... + 158 °F	
	Operation	- 25 ... + 70 °C / - 13 ... + 158 °F	
		For Storage or Operation: Temperature max. ≤ 65°C / 149 °F if moisture > 85%	
Degree of protection		IP66	

⚠ ⚠ DANGER
HAZARD OF EXPLOSION OR ARC FLASH

- Do not try to recharge the internal battery.
- Do not dismount the internal battery.
- Do not exchange the internal battery by another model.

Failure to follow these instructions will result in death or serious injury.

Product Setting

Note: The data exploitation sent by the transmitter requires an enrollment from a user account on the Schneider-Electric server.

Account creation (or account opening) on Internet XIOT platform website :

1

Open a browser (Internet Explorer, Firefox or Chrome) and copy the following address:
<https://XIOT.Tesensors.com>

2

Follow the instructions given on the screen to open or create a user account.
Then, it is necessary to enroll the transmitter from its unique identifier
(8 characters code written on the product identification label)

Label example:

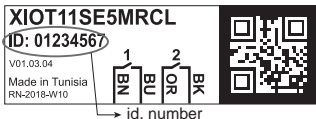

Note: This enrollment will only be validated if the server receives at least one data frame from the transmitter within a maximum of 3 minutes.

This frame can be the one sent during the activation of the transmitter (see below) or if the activation was already carried out, by the change of state of one of the inputs.

Transmitter activation:

The triggering of the frames transmission by the transmitter is performed with the magnet contained in the product packaging.

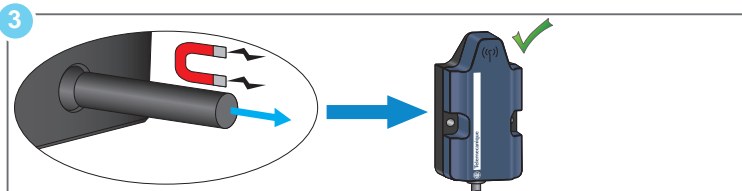
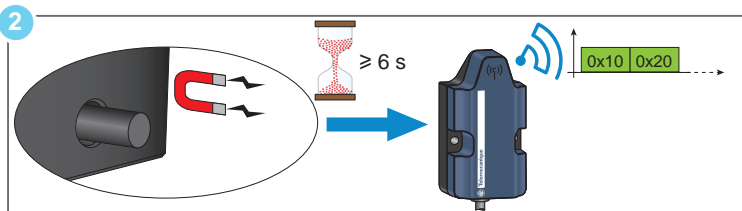
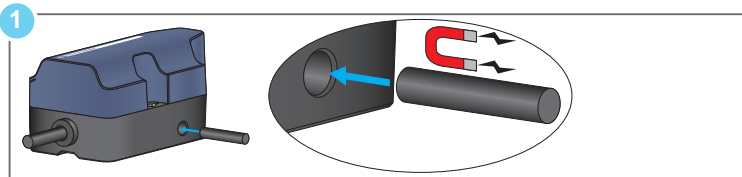

Note:

- Once activated, the XIOT11SE●●● transmitter can no longer be turned-off or deactivated.
- The subscription starts immediately after activation and can not be suspended or canceled.

When the enrollment is functional, the various menus proposed to the user make it possible to personalize the transmitted information (naming of the transmitter, localization, naming of the entries), and to set up alerts (change of entries state, alerts by email, recipients of alerts).

The user also has the possibility to consult the history of the transmitted data, his transmitters state (quality of the radio transmission, battery state), and to export the data if the user wishes it.

Data transmission

Radio frames

The transmitter sends four frame types on the SIGFOX® network:

- An event frame for sensor inputs (code0x40).
- Two frames after activation (code0x10 & code0x20).
- A keep alive frame (code0x30).

Timing diagrams

- Transmitter activation:

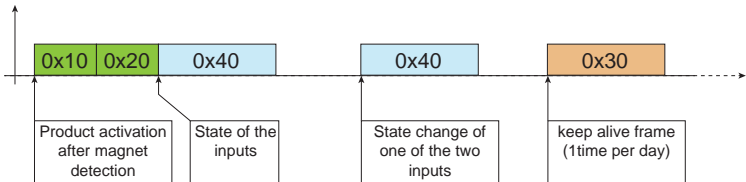

- Event during a radio transmission:

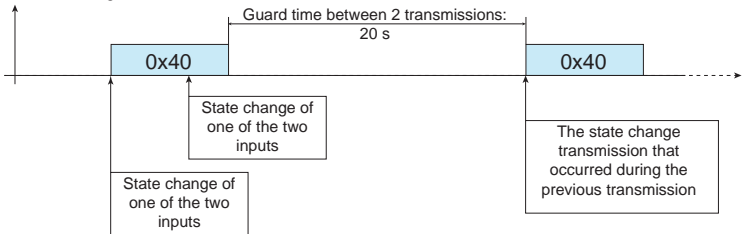

Frames description transmitted by the transmitter:

The transmitted frames are in Little endian format (least significant bit, first).

⚠ WARNING

POTENTIAL COMPROMISE OF SYSTEM AVAILABILITY, INTEGRITY AND CONFIDENTIALITY

- Place networked devices behind multiple layers of cyber defenses (such as firewalls, network segmentation, and network intrusion detection and protection).
- Use cybersecurity best practices (for example, least privilege, separation of duties) to help prevent unauthorized exposure, loss, modification of data and logs, or interruption of services.

Failure to follow these instructions can result in death, serious injury, or equipment damage.

Related Document about cybersecurity

Document title	Webpage Address
Cybersecurity System Technical Note v2 [How Can I ... Reduce Vulnerability to Cyberattacks?]	https://www.schneider-electric.com/en/download/document/STN+v2/

Transmitted frames detail

Event frame for sensor inputs (code 0x40)

Byte N°	0	1	2	3	4	5	6	7	8	9	10
	Code		Sensor 1		Sensor 2		Reserved			Sensors state (*)	
Value	0x40	Status (**)	Event counter (0x00 to 0xFF)		Event counter (0x00 to 0xFF)						

(**): see description at the page bottom

(*) Sensors state Byte

Byte N°	7	6	5	4	3	2	1	0
	Reserved			Sensor 2		Sensor 1		
					State at previous frame	Current state	State at previous frame	Current state

State:

- 0x01 if the contact is open
- 0x00 if the contact is closed

Counters:

- From 0x00 to 0xFF

Activation frame (code 0x10 - code 0x20)

Byte N°	0	1	2	3	4	5	6	7	8	9	10
Value	0x10	Status (**)	0x90	0x48	0x46	0x46	0x00	0x00	0x01	0x00	0x00

Byte N°	0	1	2	3	4	5	6	7	8	9	10
Value	0x20	Status (**)	0x01	0x01	0x00	0x00	0x00	0x00	0x00	0x00	0x00

Keep alive frame (code 0x30)

Byte N°	0	1
Code		
Value	0x30	Status (**)

() Status Byte**

Byte N°	7	6	5	4	3	2	1	0
Value	Transmitted frames counter (0x0....0x7)			Reserved		Hardware error	Low battery	0x00

Low battery bit:

- 1 if the voltage is ≤ 2.5 V
- otherwise 0

Hardware error bit:

- 1 if hardware problem on the product,
- otherwise 0

Déclaration UE de Conformité simplifiée

Simplified EU Declaration of Conformity

Nous, SCHNEIDER ELECTRIC INDUSTRIES SAS déclarons, sous notre seule responsabilité, que les équipements radioélectriques :

We, SCHNEIDER ELECTRIC INDUSTRIES SAS declare, under our sole responsibility, that the radio equipments :

Marque / Trademark : **Telemecanique**
Modèles / Models : **XIOT...**

sont conformes aux exigences essentielles des Directives Européennes suivantes :

comply with Essential Requirements of following European Directives :

**Directive Equipements
Radioélectriques :**
2014/53/UE

Radio Equipment Directive :
2014/53/EU

**Règlementations relatives à
l'exposition aux champs
électromagnétiques :**
1999/519/CE
2013/35/UE

**Regulations relative to the
exposure to electromagnetic
fields :**
1999/519/EC
2013/35/EU

Le texte complet de la Déclaration UE de Conformité est disponible à l'adresse internet suivante :

The full text of the EU Declaration of Conformity is available at the following internet address :

<http://qr.tesensors.com/XIOT0001>

XIOT Platform software

XIOT Platform software for configuration and checking of all transmitters XIOT... of your installation. This application is available for PC (https://XIOT.Tesensors.com) or Smartphone (XIOT App).

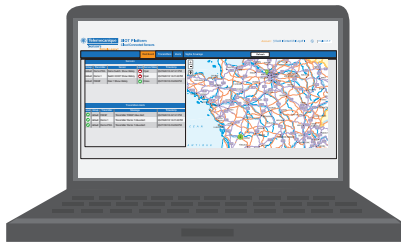

XIOT Platform
 Cloud Connected Sensors

Account: 0 Data Contact Us Logoff English

Refresh
Signal Coverage
Refresh

Setup	Transmitter	Sensor	Level	State	Timestamp
default	Demo PRA	Demo Switch	Show History	Open	02/16/2018 4:21:41 PM
default	Demo 1	Switch XOP	Show History	Open	02/16/2018 12:21:48 PM
default	FRESF	Door 1	Show History	Close	02/17/2018 2:34:58 PM

Level	Code	Transmitter	Message	Timestamp
default	FRESF	Transmitter FRESF	Alert	02/16/2018 4:21:41 PM
default	Demo 1	Transmitter Demo 1	Alert	02/16/2018 12:21:48 PM
default	Demo PRA	Transmitter Demo PRA	Alert	02/17/2018 2:34:58 PM

FRESF

From: To: 2062018 Refresh

Message	res	err	link quality	Timestamp
Switched to State 'Close'	100	0	10.0%	2/17/2018 8:34:58 PM
Switched to State 'Open'	100	0	10.0%	2/17/2018 8:34:38 PM
Switched to State 'Close'	100	0	20.0%	2/16/2018 1:20:50 PM
Switched to State 'Open'	100	0	20.0%	2/16/2018 1:20:27 PM
Switched to State 'Close'	100	0	20.0%	2/15/2018 11:36:57 AM
Switched to State 'Close'	100	0	20.0%	2/15/2018 9:34:54 AM
Switched to State 'Open'	100	0	10.0%	2/15/2018 9:34:26 AM
Switched to State 'Close'	100	0	10.0%	2/14/2018 5:38:57 PM
Switched to State 'Open'	100	0	10.0%	2/14/2018 5:38:40 PM
Switched to State 'Close'	100	0	10.0%	2/14/2018 4:00:16 PM
Switched to State 'Open'	100	0	10.0%	2/14/2018 3:59:50 PM
Switched to State 'Close'	100	0	10.0%	2/14/2018 2:27:21 PM

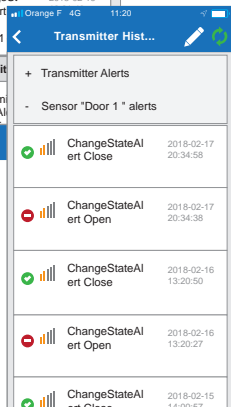
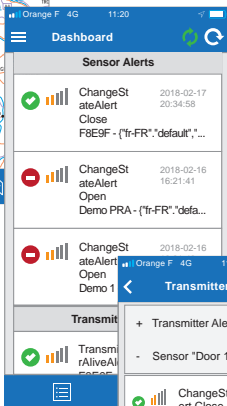
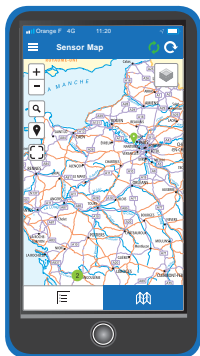

Recycling

Do not dispose of electric tools together with household waste material! In observance of European Directive 2002/96/EC on waste electrical and electronic equipment and its implementation in accordance with national law, electric tools that have reached the end of their life must be collected separately and returned to an environmentally compatible recycling facility.



RECYCLABLE

