

› GN+ Series

Performance Solid State Relays

Panel Mount - AC Output Single Phase

- › Output current of 25, 50, 90 and 125 Amps
- › Output voltage of 12-270 V \sim and 24-500 V \sim
- › Control voltage of 4-32 V --- and 20-260 V \sim
- › Special zero cross (resistive, inductive and capacitive loads)
- › Integrated IP20 touch-safe removable covers
- › High immunity levels & built-in overvoltage protection
- › LED input status indicator
- › Integrated thermal pad



Multi Load
Version

Product Selection - Special Zero Cross (Resistive, Inductive and Capacitive Loads) ⁽²⁾				
Rated Load Current	25A	50A	90A	125A
Output Voltage	12-270 V \sim	24-500 V \sim	24-500 V \sim	24-500 V \sim
Control Voltage				
4-32 V ---	84138010N	84138120N	84138150N	84138180N
20-260 V \sim	84138013N	84138123N	84138153N	84138183N

PART NUMBERING SYSTEM

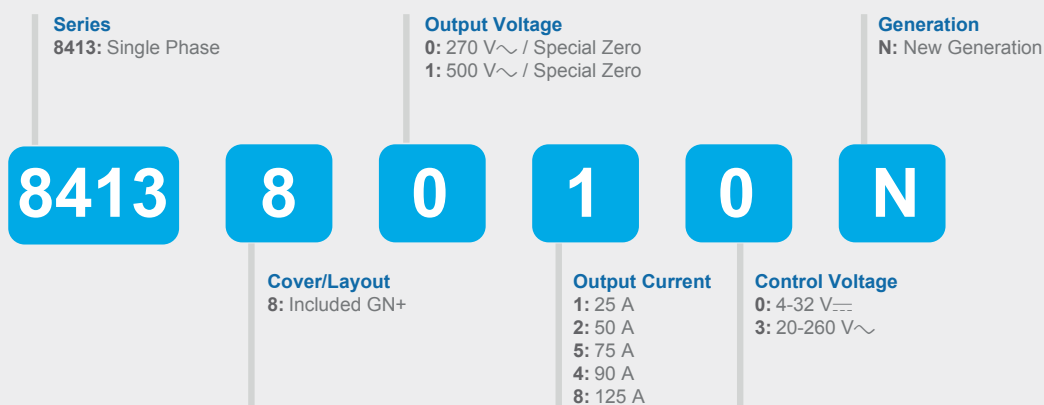

Do you need an adapted or customized solution? Contact us on www.crouzet.com

Description:

Crouzet Solid State Relays are designed to be used in almost any application, offering very long life expectancy and are easy to install, easy to use, robust and multipurpose.

For more information about Crouzet's Solid State relays, please visit www.crouzet.com.

Accessories		
Type	Description	Part-Number
Heatsink	0.9 °C/W Thermal Resistance	26532752N
Heatsink	1.1 °C/W Thermal Resistance	26532753N
Heatsink	1.2 °C/W Thermal Resistance	26532754N
Heatsink	1.75 °C/W Thermal Resistance	26532755N
Heatsink	2.2 °C/W Thermal Resistance	26532756N
Adapter	DIN Rail	26532764N
Thermal Pad	Pre-cut thermal pad	26532720N
Thermal Pad	Self-Adhesive Thermal Pad	26532722N
Screws	Screw Mounting Kit	26532001
Thermal Grease	Thermal Grease for Heatsink mounting	26532003

Output Specifications ⁽¹⁾				
Description	25A	50A	90A	125A
Maximum Load Current [Arms] ⁽³⁾	25	50	90	125
Minimum Load Current [mArms]	5			
Min / Max Operating Voltage (47-63Hz) [Vrms]	12-270 V \sim	24-500 V \sim	24-510 V \sim	
Transient Voltage [Vpk]	600 (450)	1200 (950)		
Maximum Off-State Leakage Current @ Rated Voltage [mArms]	1			
Minimum Off-State dV/dt @ Maximum Rated Voltage [V/ μ sec]	500			
1 Second Surge Current (Apk. Ta=25 °C) 50/60 Hz	95	230	347	613
Maximum 1 Cycle Surge Current (50/60 Hz) [Apeak] Typ @ 50 Hz	250/260 (min) 340 (typ)	700/_ (min) 750 (typ)	1100/_ (min) 1200 (ty)	2000/_ (min) 2100 (typ)
Maximum On-State Voltage Drop @ Rated Current [Vpeak]	1.25	1.37	1.4	1.15
Thermal Resistance Junction to Case (Rjc) [°C/W]	1.7	0.4	0.3	0.25
Maximum 1/2 Cycle I ² t for Fusing @ 50 Hz (min. / typical) [A ² sec]	340/600	2450/2800	6000/7200	20000/22000
Minimum Heat Sink for Rated Current @ 40 °C [°C/W]	1.3	0.78	0.33	0.29

Input Specifications		
Description	4-32 V $_{DC}$	20-260 V $_{AC}$
Input Voltage Range	4-32 V $_{DC}$ ⁽⁴⁾	20-260 V $_{AC}$
Maximum Reverse Voltage	-32 V $_{DC}$	N/A
Minimum Turn-On Voltage	3 V $_{DC}$	18 V $_{AC}$
Must Turn-Off Voltage	2 V $_{DC}$	5 V $_{AC}$
Minimum Input Current (for on-state)	10 mA	6.5 mA AC / 4.5 mA DC
Maximum Input Current [mA]	14 mA	10 mA
Nominal Input Impedance [Ohms]	Current Limited	
Maximum Turn-On Time [msec]	1/2 Cycle ⁽⁵⁾	
Maximum Turn-Off Time [msec]	1/2 Cycle ⁽⁵⁾	

General Specifications				
Description	25A	50A	90A	125A
Dielectric Strength, Input to Output (50/60 Hz)	4000 Vrms			
Dielectric Strength, Input/Output to Ground (50/60 Hz)	4000 Vrms			
Minimum Insulation Resistance (@ 500 V $_{DC}$)	10 ⁹ Ω			
Maximum Capacitance, Input/Output	0.8 pF			
Ambient Operating Temperature Range ⁽⁷⁾	-40 to 80 °C			

General Specifications				
Description	25A	50A	90A	125A
Ambient Storage Temperature Range	-40 to 100 °C			
Weight (typical)	80 g			
Housing Material	UL94 V-0			
Baseplate Material	Aluminum			
Input Terminal Screw Torque Range (in-lb/Nm)	11-18 / 1.2-2.0			
Load Terminal Screw Torque Range (in-lb/Nm)	18-26 / 2-3			
SSR Mounting Screw Torque Range (in-lb/Nm)	11-16 / 1.2-1.8			
Humidity per IEC60068-2-78	40-85 %			
LED Input Status Indicator	Green			
MTBF (Mean Time Between Failures) at 40 °C ambient temperature (years) ⁽⁵⁾	72			
MTBF (Mean Time Between Failures) at 60 °C ambient temperature (years) ⁽⁵⁾	46			

General Notes
⁽¹⁾ All parameters at 25 °C unless otherwise specified
⁽²⁾ Allows to support multi loads such as resistive, capacitive and Inductive loads
⁽³⁾ Heat sinking required, see derating curves
⁽⁴⁾ Increase minimum voltage by 1V for operations from -20 to -40 °C
⁽⁵⁾ All parameters at 50 % power rating and 100 % duty cycle (contact tech support for detailed report)

Diagrams

Wiring

GN+ -

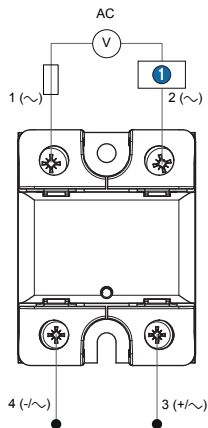

TERMINALS	WIRE SIZE		Terminal Screw Torque (N.m)
	SOLID	STRANDED	
Input	18..14 AWG (0.75..2.5 mm ²) 2 x 18..14 AWG (0.75..2.5 mm ²)	18..14 AWG (0.75..2.5 mm ²) 2 x 18..14 AWG (0.75..2.5 mm ²)	1.2 - 2
Output	16..8 AWG (1.5..10 mm ²) 2 x 16..8 AWG (1.5..10 mm ²)	16..8 AWG (1.5..6 mm ²) 2 x 16..10 AWG (1.5..6 mm ²)	2 - 3

Protection in the mains (fuses/circuit breaker)

① Load

Diagrams

Equivalent Circuit Block

GN+ Series DC control - 50 A / 90 A / 125 A

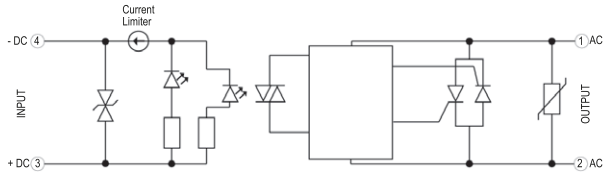

Input current vs Input Voltage
Standard Regulated DC inputs

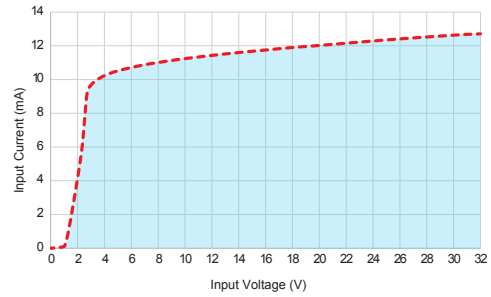

GN+ Series DC Triac - 25 A

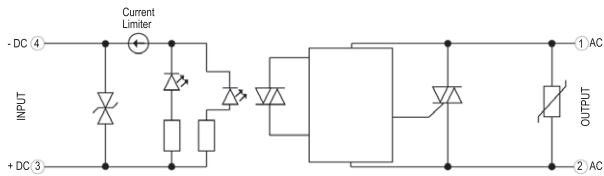

Input current vs Input Voltage
Standard Regulated DC inputs

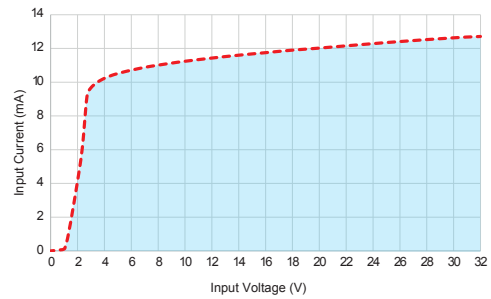

GN+ Series AC/DC control - 50 A / 90 A / 125 A

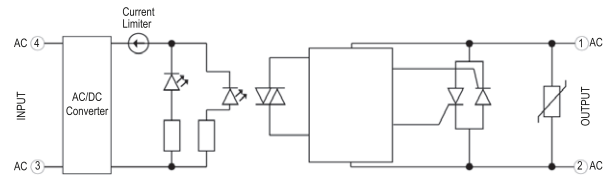

Input current vs Input Voltage
Standard Regulated AC/DC inputs

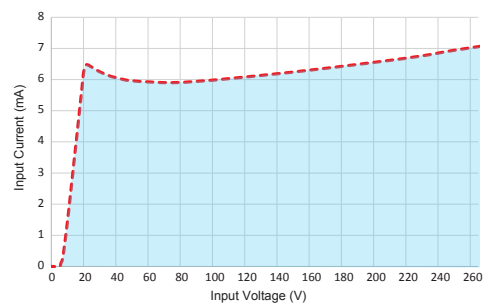

GN+ Series AC/DC Triac - 25 A

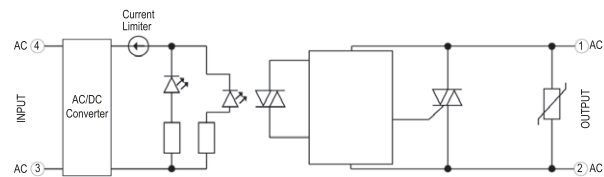

Input current vs Input Voltage
Standard Regulated AC/DC inputs

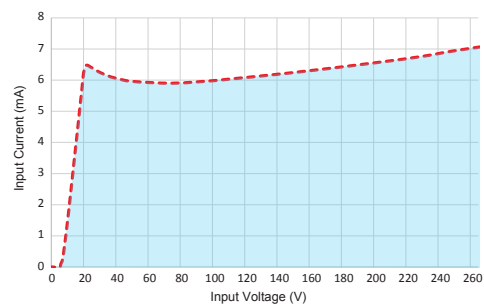

Diagrams

Dimensions (mm)

GN+ front view

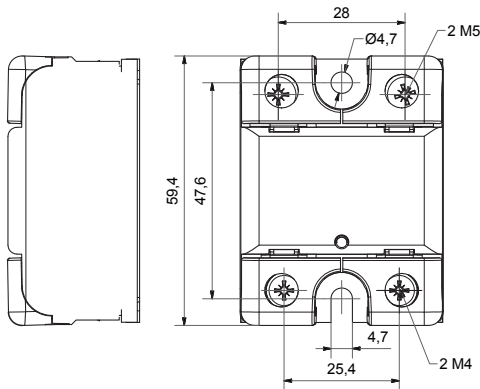

GN+ side view

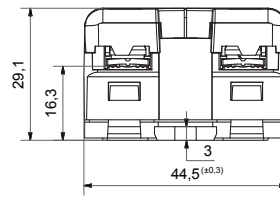

Curves

Surge Current Information

GN+ - 25 A

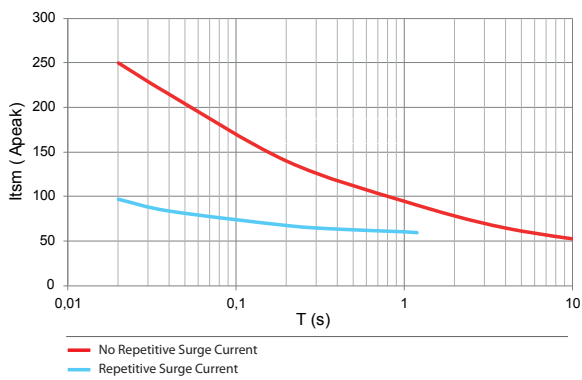

GN+ - 50 A

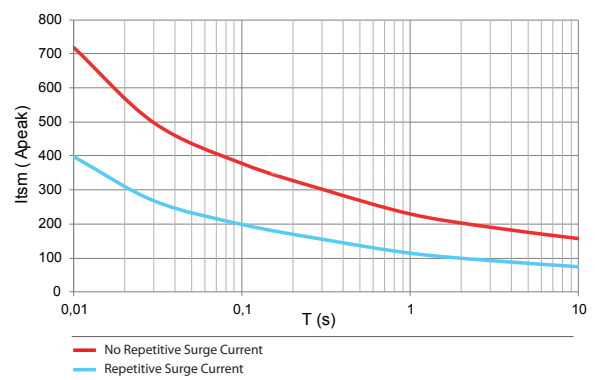

GN+ - 90 A

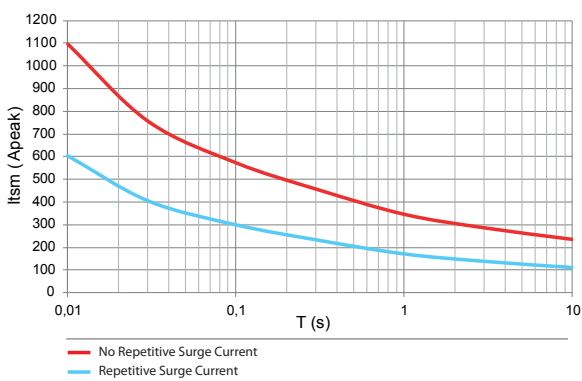

GN+ - 125 A

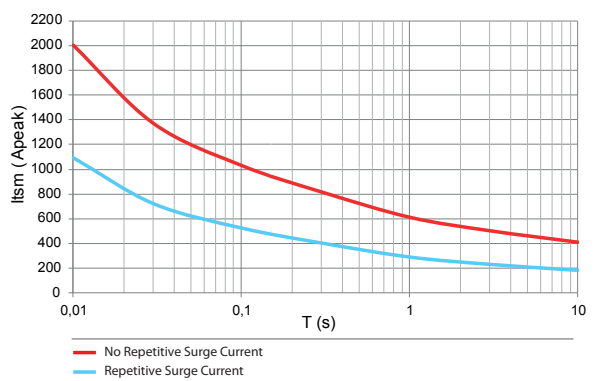

Curves

Thermal Derating Curves

GN+ - 25 A

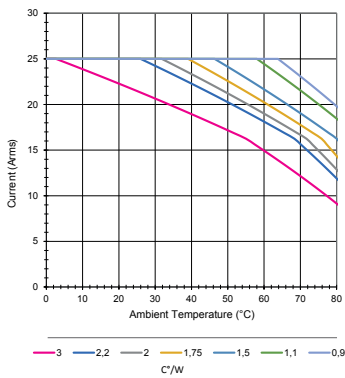

GN+ - 50 A

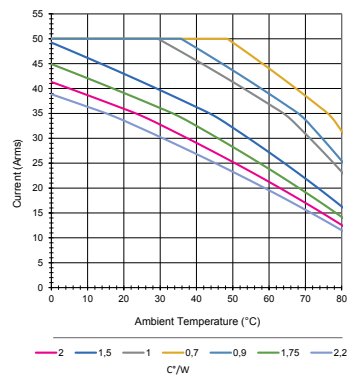

GN+ - 90 A

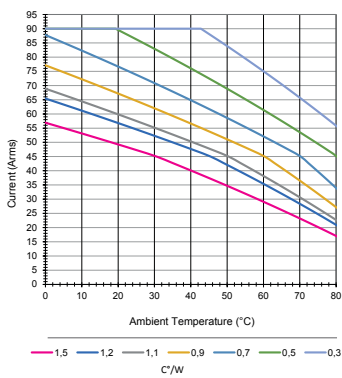

GN+ - 125 A

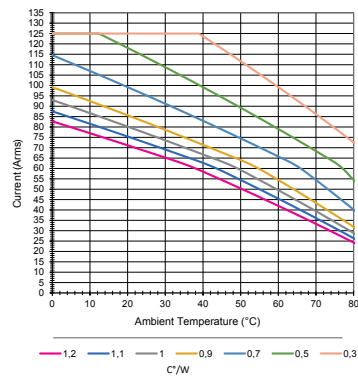

Standards Specifications

IEC/EN61000-4-4 (bursts)

IEC/EN61000-4-5 (surge)

VIBRATION resistance IEC 60068-2-6

SHOCK resistance IEC 60068-2-27

2 kv crit A

2 kv crit A

10 g

50 G (11 ms)



Warning:

The product information contained in this catalogue is given purely as information and does not constitute a representation, warranty or any form of contractual commitment. Crouzet and its subsidiaries reserve the right to modify their products without notice. It is imperative that we should be consulted over any particular use or application of our products and it is the responsibility of the buyer to establish, particularly through all the appropriate tests, that the product is suitable for the use or application. Under no circumstances will our warranty apply, nor shall we be held responsible for any application (such as any modification, addition, deletion, use in conjunction with other electrical or electronic components, circuits or assemblies, or any other unsuitable material or substance) which has not been expressly agreed by us prior to the sale of our products.