

## DATA SHEET

# KISTOCK DATA LOGGERS KP 320 / KP 321

## Diferential pressure



### Features

- Software for configuration and data visualisation freely downloadable
- Software for configuration and data processing available in option
- Safety lock wall mount with inviolability system
- Storage capacity of 2,000,000 points
- Fast data downloading: 18,000 points/s
- 2 configurable setpoint alarms for each channel
- 2 lines LCD screen
- Wireless connection for smartphones and tablets (Android and iOS)
- Magnetic mounting

### References

| Reference | Display | Internal sensor         | External sensor | Parameter            |
|-----------|---------|-------------------------|-----------------|----------------------|
| KP 320    | Yes     | 1: Diferential pressure | -               | Diferential pressure |
| KP 321    | Yes     | 1: Diferential pressure | -               | Diferential pressure |

### General features

|                                 |  |
|---------------------------------|--|
| Display                         | 2 lines LCD screen<br>Dimensions of screen: 49.5 x 45 mm<br>2 indication LEDs (red and green)            |
| PC communication                | 1 micro-USB input  |
| Power supply                    | 2 x AA lithium 3.6 V battery   |
| Protection                      | IP65*  |
| Material                        | Compatible with food industry environment<br>ABS housing   |
| Dimensions                      | 110.2 x 79 x 35.4 mm   |
| Weight (with batteries)         | 206 g  |
| Environmental conditions of use | Air and neutral gases<br>Hygrometry: in non-condensing conditions (< 80% RH)<br>Maximum altitude: 2000 m |
| Warranty                        | 1 year   |

\* With the pressure connectors plugged

## Technical specifications

|                           | KP 320  | KP 321                  |
|---------------------------|---|-------------------------|
| Units displayed           | Pa  | Pa                      |
| Resolution                | 1 Pa  | 1 Pa                    |
| Tolerated overpressure    | 21,000 Pa   | 69,000 Pa               |
| Measuring range           | ±1000 Pa  | ±10,000 Pa              |
| Accuracy*                 | ±0.5% of reading ±3 Pa  | ±0.5% of reading ±30 Pa |
| External input            | Micro-USB female connector                                      |                         |
| Input probe               | 2 pressure connections  |                         |
| Setpoints alarm           | 2 setpoint alarms on each channel                               |                         |
| Frequency of measurements | From 1 second to 24 hours                                       |                         |
| Operating temperature*    | From 0 to +50 °C  |                         |
| Storage temperature       | From -40 to +85 °C  |                         |
| Battery life              | 7 years**   |                         |
| European directives       | 2011/65/UE RoHS II; 2012/19/UE DEEE; 2014/30/UE CEM; 2014/35/UE |                         |

\* All accuracies indicated in this document were stated in laboratory conditions and can be guaranteed for measurement carried out in the same conditions, or carried out with calibration compensation.

\*\* On the basis of 1 measurement each 15 minutes at 25 °C.

## Recorder function

### Five recording modes

KISTOCK can record in 5 different ways:

- **"Immediate"** mode records values according to a predefined interval.
- **"Minimum"**, **"Maximum"** and **"Average"** record automatically the calculation of minimum, maximum or average of measured values during an interval of recording.
- **"Monitoring"** mode allows to get an accurate history report during error events to help troubleshooting, without stopping the measurement logging. To proceed this way, you just have to define:
  - a record interval to be used whilst the readings are beyond the setpoints
  - a record interval for the values measured during each reading beyond the setpoints
- Furthermore, you can also let your KISTOCK record non-stop (**"loop"** recording option).

### Four types of dataset start

Once your recording mode has been set, you can launch your dataset:

- With a delayed start (with predefined date and time)
- With the software
- With push-button
- With **"Online"** option. In this case, your datasets are directly sent, saved and displayed on your PC in real time.

### Six types of dataset stop

You can stop your dataset:

- According to a date and time (if it was started the same way)
- According to a period
- According to a predefined number of recording points
- Once the storage capacity is full
- With **"Stop"** option of the software
- By holding **"OK"** key during 5 seconds, if this function has been previously activated by the software

## Dimensions (mm)

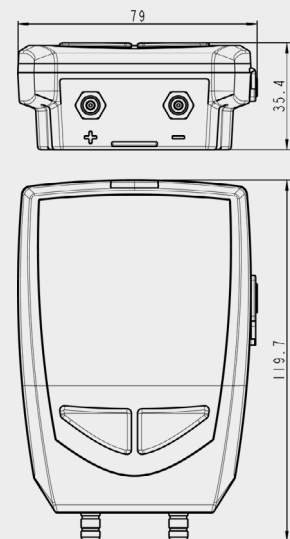

## Connection



Two pressure connections

## PC connection



Micro-USB connector

## Display

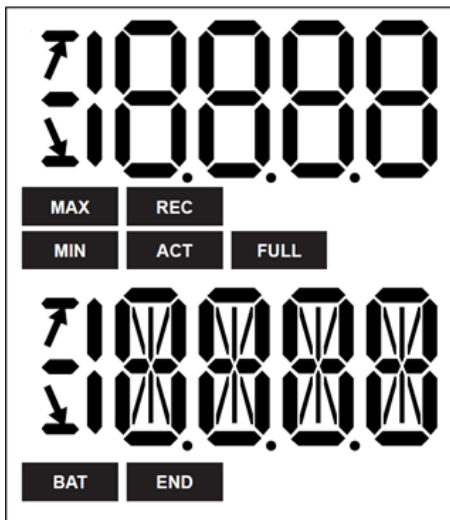

- END** DATASET is finished.
- REC** Indicates that one value is being recorded.  
It flashes: the DATASET did not start already.
- FULL** Flashing slowly: DATASET is between 80 and 90% of the storage capacity.  
Flashing quickly: DATASET is between 90 and 100% of the storage capacity.  
Constant: storage capacity full.
- BAT** Constant: indicates that the batteries have to be replaced.
- 1 2**  
**3 4** Indicates the channel number which is measuring.
- ACT** Screen actualisation of measured values.
- MIN** The displayed values are the maximum/minimum values recorded for the channels displayed.
- MAX**
-  Indication of the direction of exceeding the threshold in the recorded measurement

## Mounting

The KISTOCK class 320 have a magnetic mounting, so you can fix it easily.

## Replace the battery



With 4 years\* of battery life, the KISTOCK devices guarantee long-term measurements.

To replace the battery:

- Unscrew the 4 screws on the back side of the device with a screwdriver.
- Remove the back side and the old batteries.
- Insert the new battery and respect the polarity.
- Replace the back side and the 4 screws

\* On the basis of 1 measurement each 15 minutes at 25 °C.

## Safety lock wall mount with padlock



Mount the safety lock support on the required place.

1. Present the KISTOCK data logger on the support starting with the inferior part
2. Clip the KISTOCK on the support by falling back the superior part
3. Insert the padlock to ensure the safety lock function

 The padlock can be replaced by a fail-safe sealed.

 The data logger can be placed on the screw-mount without the safety lock function.

- To remove the data logger from the support, proceed on reverse order.

## Magnetic mounting

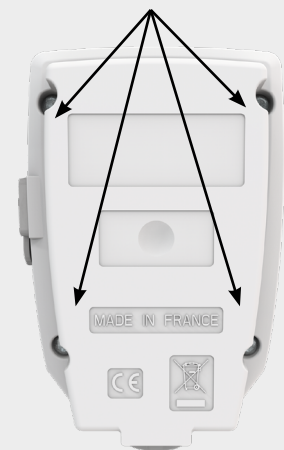

## Dimensions of the wall mount (mm)

Front view

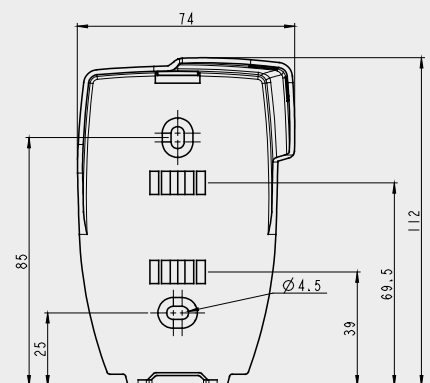

Side view

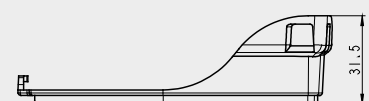

## Software

**Kilog Lite:** free software to download on [sauermanngroup.com](http://sauermanngroup.com)

Allows the data download (graphics and points statement) and the data logger configuration.

### Configuration and data processing software

KILOG software allows to configure, save and process your data in a very simple way.

- **Software only:** Ref. KILOG-3-N
- **Complete set:** software + 1 USB cable, Ref. KIC-3-N

## Accessories

| Accessories  | Reference |
|--|-----------|
| 1 AA lithium 3.6 V battery<br> 2 batteries are required for class 320 data loggers                                      | KBL-AA    |
| Safety lock wall mount with padlock  | KAV-320   |
| Wired extension for class 220 KISTOCK probes<br>In polyurethane, 5 m length with male and female mini-DIN connectors<br>Note: several extensions can be wired in order to obtain up to 25 m cable length | KRB-320   |
| Data collector<br>Collects up to 20,000,000 points from one or several KISTOCK directly on-site.<br>Results restitution on PC of realised datasets   | KNT-320   |
| USB micro-USB cable which allows to plug your KISTOCK data logger to your PC   | CK-50     |

 Only the accessories supplied with the device must be used.

## Maintenance

Please avoid any aggressive solvent.

Please protect the device and probes from any cleaning produce containing formalin, that may be used for cleaning rooms and ducts.

## Calibration

A calibration certificate is available as option in paper format.

We recommend to carry out a yearly checking.

## Guarantee period

KISTOCK data loggers have 1-year guarantee for any manufacturing defect (return to our After-sales service required).

## Precautions for use

Please always use the device in accordance with its intended use and within parameters described in the technical features in order not to compromise the protection ensured by the device.

 **BE CAREFUL!** Material damages can happen, so please apply the precautionary measures indicated.

Once returned to Sauermann, required waste collection will be assured in the respect of the environment in accordance to guidelines relating to WEEE.

