

## 48 x 48 Hour and impulse CMM48 Part number 99779714



- Dual-function counter (hour counter and impulse counter)
- VAC : capacity 100,000 hrs (99,999.99 hrs)
- VDC : capacity 1,000,000 hrs (999,999.99 hrs)
- Operation indicator
- Panel mounted
- IP52
- Highly resistant to shocks and impacts
- Excellent visibility thanks to the large digit size

### Part numbers

	Type	Operating frequency (Hz)	Voltages
99779714	CMM48	50	187 →264 VAC

### Specifications

#### General characteristics

Counting capacity	VAC : 99,999.99 hrs VDC : 999,999.99 hrs
Reset to zero	Not included
Read accuracy	1/100 h
Height digits (mm)	4
Colour of hour numbers	White on a black background
Colour of decimal digits	Red on a black background
Accuracy	VAC : frequency + 30 ms VDC : < 0.003 % (24 hrs)
Counting input mode	Addition
Operation indicator	VAC : rotating red lines VDC : 1/100 hr 1 digit in 36 s
Degree of protection front face	IP52
Mounting position	Any
Temperature limits use (°C)	-15 →+50
Temperature limits stored (°C)	-40 →+80
Certifications	CE - UL (pending)
Connections (panel mounted version)	Screw terminals - 6.35 mm Faston connectors
Connection capacity	2.5 mm <sup>2</sup>
Consumption	VDC : 10 →30 approx. 1 W VAC 50 Hz : 20 →30 approx. 0.53 VA 100 →130 approx. 1.43 VA/187 →264 approx. 3 VA
Vibration resistance	50 m/s <sup>2</sup> (10-500 Hz) IEC 68-2-6
Test voltage for AC models	2 000 VAC 50 Hz
Weight (g)	65

### Accessories

Description	Code
Adaptor for 72 x 72 mm cut-out	26546842
Adaptor for 55 x 55 mm cut-out	26546846

### Dimensions (mm)

#### Panel mounted

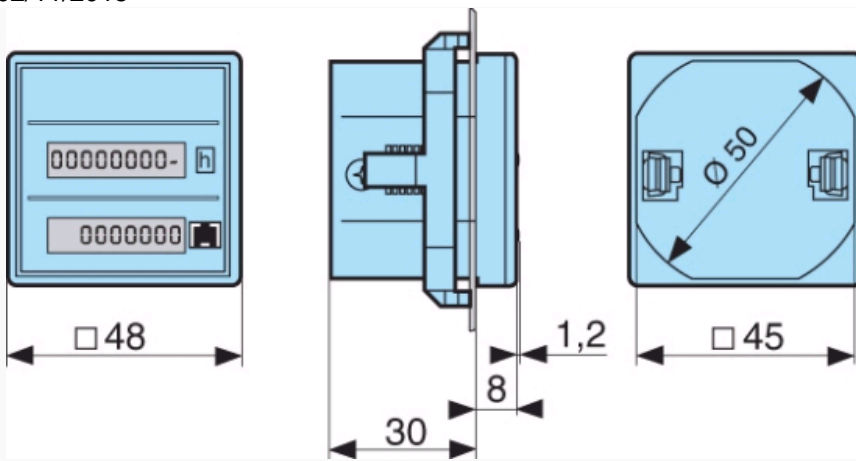

Dimensions (mm)

Panel cut-out

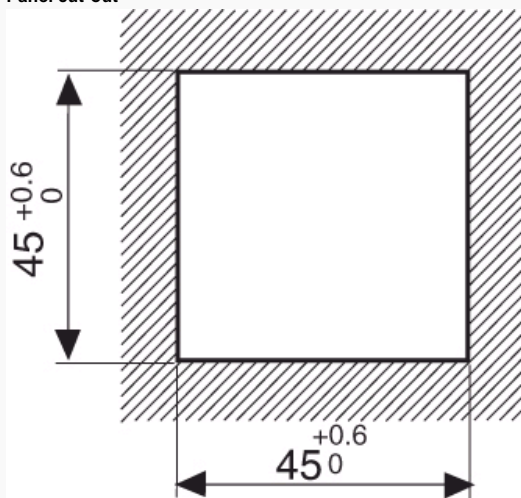

Dimensions (mm)

26546842 - Adaptor for 72 x 72 mm cut-out

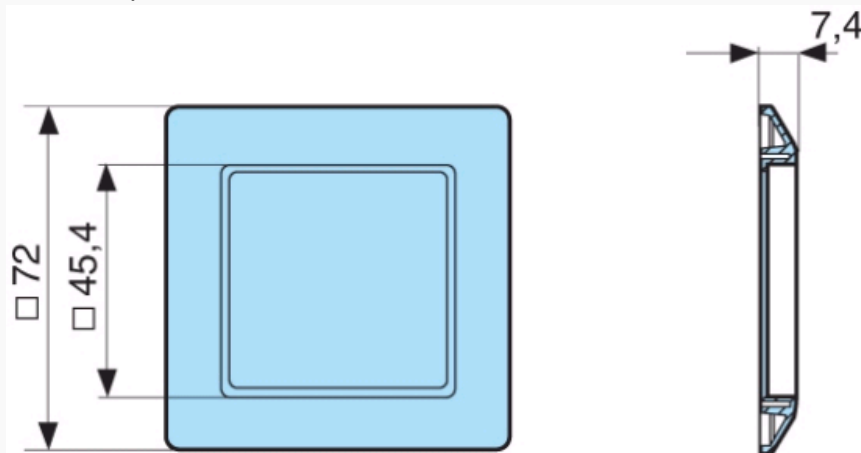

Dimensions (mm)

26546846 - Adaptor for 55 x 55 mm cut-out

