

PyroMini Series Operators Guide



Guide de l'opérateur pour la série PyroMini
PyroMini Bedienungsanleitung
Serie PyroMini Guida del operario
Serie PyroMini Manuale di istruzione

CALEX
ELECTRONICS LIMITED

The PyroMini Series is a range of miniature non-contact infrared temperature sensors with separate electronics modules.

All models have an adjustable emissivity setting and are capable of measuring a wide variety of target materials, including food, paper, textiles, plastics, leather, tobacco, pharmaceuticals, chemicals, rubber, coal and asphalt.

The optional touch screen interface provides temperature indication, alarms, sensor configuration and data logging to MicroSD Card. The optional high-temperature sensing head may be used in ambient temperatures of up to 180°C without cooling. The low-noise cable on high ambient temperature models is resistant to interference from movement, so it is ideal for mounting on moving objects such as robot arms.

A choice of optics are available to measure small or large targets at short or long distances, and there is a choice of 4-20 mA, RS485 Modbus and alarm relay outputs.

SPECIFICATION

GENERAL

Temperature Range	See table of Model Numbers
Maximum Temperature Span (-CRT models)	1020°C
Minimum Temperature Span (-CRT models)	100°C
Output	4 to 20 mA or RS485 Modbus
Field of View	See table of Model Numbers
Accuracy	± 1°C or 1%, whichever is greater
Repeatability	± 0.5°C or 0.5%, whichever is greater
Emissivity Setting Range	0.20 to 1.00
Emissivity Setting Method	-CB models: via two rotary switches in electronics module -BB and -BT models: via RS485 -CRT and -BT models: via touch screen
Response Time, t_{90}	240 ms (90% response)
Spectral Range	8 to 14 μ m
Supply Voltage	24 V DC ± 5%
Maximum Current Draw	100 mA
Maximum Loop Impedance	-CB and -CRT models: 900 Ω (4 to 20 mA output)
Alarm Relays (-CRT models)	2 x Single Pole Changeover alarm relays rated 24 V DC, 1 A, isolated 500 V DC

MECHANICAL

	Sensing head	Electronics Module
Construction	Stainless Steel 316	Die-cast Aluminium
Major Dimensions	Ø18 x 45 mm	98(w) x 64(h) x 36(d) mm
Mounting	M16 x 1 mm thread	Two M4 screws for wall mounting (see diagram)

Cable Length (sensing head to electronics module)	1 m (standard), up to 30 m (optional)
Weight with 1 m Cable	390 g (approx)
Cable Connections	Removable screw terminal blocks (see Connections). Conductor size: 28 AWG to 18 AWG
Output Cable Gland	Suitable for cable diameters 3.0 to 6.5 mm

ENVIRONMENTAL

	Sensing Head	Electronics Module (without touch screen)	Electronics Module (with touch screen)
Environmental Rating	IP65 (NEMA 4)	IP65 (NEMA 4)	–
Ambient Temperature Range	See table of Model Numbers	0°C to 60°C	0°C to 60°C
Relative Humidity	Maximum 95% non-condensing	Maximum 95% non-condensing	Maximum 95% non-condensing
CE Marked	Yes	Yes	Yes
RoHS Compliant	Yes	Yes	Yes

ELECTROMAGNETIC COMPATIBILITY STANDARDS:

Class	Standard	Description
EMC Directive	EN61326-1:2006	Electrical equipment for measurement, control and laboratory use – Industrial
- Immunity	IEC 61000-4-2	Electrostatic Discharge Immunity
	IEC 61000-4-3	Electromagnetic Field Immunity
	IEC 61000-4-4	Burst Immunity
	IEC 61000-4-5	Surge Immunity
	IEC 61000-4-6	Conducted RF Immunity
- Emissions	EN 55022A	RF Emissions Class A
	EN 55022B	RF Emissions Class B

MODEL NUMBERS

The following combinations of ambient temperature range, optics, measured temperature range, output and interface are available on PyroMini sensors:

Series	Sensing Head Operating Temperature Range	Field of View	Measurement Temperature Range	Output and Interface
PM	MA	21 151 301 CF	LT MT HT XT	CB
			CT	CRT BB BRT
	HA	201	HT XT	CB
			CT	CRT BB BRT

SENSING HEAD OPERATING TEMPERATURE RANGE

- MA** 0°C to 60°C
- HA** 0°C to 180°C

The high ambient temperature sensing head on -HA models is capable of withstanding temperatures of up to 180°C without cooling. It is available with 20:1 optics.

There is no need to supply cooling air or water, and the miniature sensing head is much smaller than bulky, cooled sensors.

FIELD OF VIEW

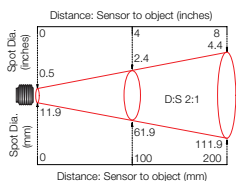

-21

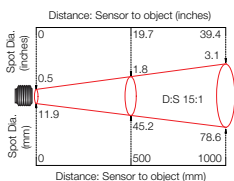

-151

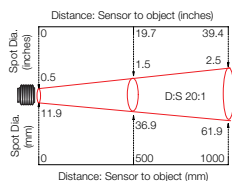

-201

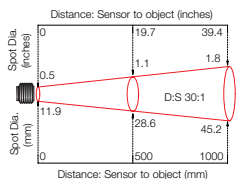

-301

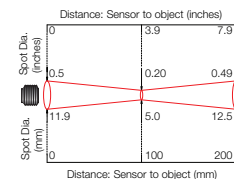

-CF

Diameter of target spot measured versus distance from sensing head at 90% energy

MEASUREMENT TEMPERATURE RANGE (°C)

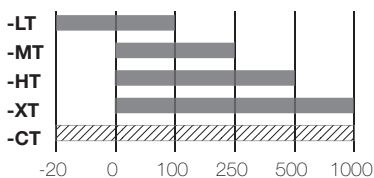

■ Fixed (e.g. -MT: 0°C @ 4 mA, 250°C @ 20 mA)

▨ -CRT models: 4 to 20 mA output configurable within this range
 -BRT and -BB models: Digital output, full temperature range

OUTPUT AND INTERFACE

- CB** 4 to 20 mA output, no touch screen
- CRT** 4 to 20 mA output and two alarm relay outputs, with touch screen
- BB** RS485 Modbus output, no touch screen
- BRT** RS485 Modbus output and two alarm relay outputs, with touch screen

EXAMPLE: PM-MA-301-CT-BRT

Series	Sensing Head Operating Temperature	Optics	Temperature Range	Output and Interface
PM PyroMini	-MA 0°C to 60°C	-301 30:1 divergent	-CT configurable within the limits: -20 to 1000 °C	-BRT RS485 Modbus output and two alarm relay outputs, with touch screen

EMISSIVITY ADJUSTMENT (-CB MODELS)

The emissivity setting on PyroMini -CB models may be adjusted via two rotary switches inside the electronics box. To adjust the emissivity setting:

Set the left switch to the first digit after the decimal point (0.1).

Set the right switch to the second digit after the decimal point (0.01).

To enter an emissivity setting of 1.00, set both switches to 0.

The minimum emissivity setting is 0.2. If a lower emissivity setting is selected, the sensor will default to an emissivity setting of 0.95.

For example:

Left switch	Right switch	Emissivity setting
6	3	0.63
0	0	1.00

TOUCH SCREEN (-CRT AND -BRT MODELS)



The optional backlit touch screen interface mounted in the lid of the electronics module provides a large, bright display of the measured temperature, as well as options for full configuration of the sensor. The graph view shows the history of the measured temperature.

In alarm conditions, the display changes colour to provide an immediate and obvious alarm indication. Alarm modes and levels can be configured via the touch screen.



TOUCH SCREEN SPECIFICATIONS



Touch Screen Display Format	2.83" (72 mm) resistive touch TFT, 320 x 240 pixels, backlit
Configurable Parameters	Temperature range, temperature units, emissivity setting, reflected energy compensation, alarms, signal processing, Modbus address (-BRT models), date and time, data logging
Temperature Units	°C or °F configurable
Temperature Resolution	0.1°
Alarm Configuration	Two alarms with adjustable level, individually configurable as HI or LO. Alarm 2 can be set to target temperature or sensing head internal temperature
Signal Processing	Average, peak hold, valley hold, minimum, maximum



USER INTERFACE

Default View	Temperature View Displays a large indication of the measured temperature. The background turns bright red when an alarm is activated.
Setting Temperature Units Selecting Displayed Temperature  	Press “°C” to switch to °F and vice versa. The units are changed throughout the interface. Press the temperature display to select which reading is shown: Filtered Temp The measured temperature, with averaging and hold processing. This temperature is output by the sensor on the 4 to 20 mA output (-CB and -CRT models). Average Temp The measured temperature with averaging but without hold processing. Unfiltered Temp The unprocessed measured temperature. MicroSD Card status. This icon is displayed when an SD card is inserted, and flashes when data logging is in progress. This icon is displayed when scheduled data logging is enabled and has yet to begin.



	List View Displays a list of the measured temperatures, alarm state and data logging state.
	Filtered Temp: The measured temperature, with averaging and hold processing. Unfiltered Temp: The unprocessed measured temperature. Average Temp: The Unfiltered Temperature averaged over the period specified in “Output Processing”. Maximum Temp: The highest temperature measured during the hold period, with averaging. Minimum Temp: The lowest temperature measured during the hold period, with averaging. Sensor Temp: The internal temperature of the sensing head. Reflected Temp: The reflected energy compensation temperature, as specified in “Emissivity and Compensation”.

 	<p>Lock/Unlock Prevents settings being changed via a four-digit numerical code.</p> <p>The default password is 1234.</p>
	<p>Change Password Enter, confirm and save a new four-digit code.</p>



 	<p>Start/Stop Logging Manually begins or ends data logging (requires MicroSD Card, available separately).</p> <p>If Scheduled Start is enabled in Settings > Data Logging, then logging cannot be started manually.</p> <p>To manually start logging, you must first disable Scheduled Start.</p>
--	---

	<p>Graph Displays the recent history of the Filtered Temperature and the Sensor Temperature. To scroll backwards and forwards in time, touch the graph and drag it. The graph stores the most recent 24 hours of temperature data.</p>
	<p>Reset Graph Clears and restarts the graph.</p>
	<p>Real-Time Scrolling View Returns the graph to the real-time scrolling view, showing the most recent measurements.</p>

	<p>Acknowledge Alarms Switches the relay outputs for triggered alarms to their normal, untriggered state. The background of the Temperature View, List View and Graph View will stay red, and the alarms will not be triggered again, until the alarms are reset (see "Alarms" below). Alarms can be acknowledged when the display is locked.</p>
---	--

	<p>Settings Access the configuration parameters. Press Apply  to save the settings, or Exit  to leave the screen without saving.</p>
---	---



SETTINGS

	<p>Date & Time Change the date and time for data logging purposes. The clock is reset when the power is cycled unless a battery is fitted.</p>
 <p>Averaging Period</p> <p>Hold Mode</p> <p>Hold Period</p>	<p>Output Processing</p> <p>Set the time, in seconds, over which the measured temperature is averaged. Note: averaging prevents the sensor from following rapid temperature changes. Minimum: 0 (no averaging). Maximum: 60.</p> <p>Peak The sensor holds the maximum temperature steady for the Hold Period. After this, the sensor responds normally. If the sensor detects a higher temperature, it holds this temperature steady for the Hold Period.</p> <p>Valley Similar to Peak Hold mode except that the sensor outputs the minimum detected temperature steady for the Hold Period.</p> <p>Off Disables hold processing.</p> <p>Set the time, in seconds, for the sensor to hold the temperature as above. Minimum: 0 (no hold processing). Maximum: 1200.</p>
 <p>Sample Period</p> <p>Number of Samples</p> <p>Enable Scheduled Start</p> <p>Date and Time</p>	<p>Data Logging</p> <p>The time, in seconds, between samples. Minimum: 1. Maximum: 86,400 (1 day).</p> <p>The number of samples to collect before logging stops. Minimum: 0 (continuous logging). Maximum: 86,400 (1 day of data if Sample Period = 1 second).</p> <p>The sensor begins logging at the Date and Time specified. Logging can also be started and stopped manually.</p> <p>The date and time for scheduled logging to start.</p>



	<p>Emissivity and Compensation</p>
<p>Emissivity Setting</p> <p>Enable Reflected Energy Compensation</p> <p>Reflected Temperature</p>	<p>Enter the emissivity of the target. Target emissivity can be determined experimentally, or estimated using an emissivity table. For more information, contact Calex. Minimum: 0.2. Maximum: 1.0.</p> <p>If enabled, compensates for errors caused by reflected energy from hotter or colder objects.</p> <p>Enter the temperature of the surroundings of the target for Reflected Energy Compensation. Minimum: -20°C. Maximum: 1000°C.</p>

	<p>4 to 20 mA Output (-CRT models)</p> <p>Set the temperature range limits for the 4 to 20 mA output.</p>
<p>Temperature at 4 mA</p> <p>Temperature at 20 mA</p> <p>Please note</p>	<p>The lower temperature range limit. Minimum: -20°C. Maximum: 900°C.</p> <p>The upper temperature range limit. Minimum: 80°C. Maximum: 1000°C.</p> <p>The difference between the temperatures at 4 mA and at 20 mA must be at least 100°C. The temperature at 20 mA must be greater than the temperature at 4 mA.</p>

	<p>Modbus Address (-BRT models)</p>
<p>Modbus Address</p>	<p>The current Modbus address of the sensor is displayed. Enter a new address, then press Apply to save it to the sensor. Cycle the power to use the new address.</p> <p>Minimum: 1. Maximum: 247.</p>

	<p>Alarms</p> <p>Configure the settings for Alarm 1 and Alarm 2 separately, and configure alarm logging settings.</p>
	<p>Manually Reset Alarms</p> <p>If an alarm has been triggered, allows both alarms to be triggered again. Alarms will not be triggered again until they are reset, either automatically or manually.</p>

SETTINGS > ALARMS

	<h3>Alarm 1 and Alarm 2</h3>
Alarm Set Point	<p>The temperature at which the alarm is triggered. Minimum: -20°C. Maximum: 1000°C.</p>
Hysteresis	<p>The temperature difference between the Alarm Set Point and the reset temperature. Hysteresis is only used when Automatic Reset is enabled. Please see the diagrams below for more information Minimum: 0°C (hysteresis disabled). Maximum: 1000°C.</p>
Filtered Temperature or Sensor Temperature (Alarm 2 only)	<p>Select the temperature monitored by Alarm 2.</p>
Alarm Type	<p>High The alarm is triggered when the temperature rises above the Alarm Set Point. Low The alarm is triggered when the temperature drops below the Alarm Set Point. Off The alarm is disabled.</p>
Reset	<p>Automatic The alarm is acknowledged and reset automatically when the temperature reaches the reset temperature (see Hysteresis). It can also be acknowledged or reset manually. Manual The alarm is acknowledged by pressing Acknowledge  on the Temperature View or List View, and reset by pressing Reset  on the Alarms screen.</p>

	<h3>Alarm Logging</h3> <p>Alarm events can be logged to the MicroSD Card. Alarm log files and settings are independent from Data Logging.</p>
Log Trigger Time	<p>The time that an alarm is triggered will be logged.</p>
Log Data While Triggered	<p>Data logging will start when an alarm is triggered. 1 sample is logged per second. Logging stops when both alarms are reset.</p>
Log Acknowledge Time	<p>The time that the alarm is acknowledged will be logged.</p>
Log Reset Time	<p>The time that the alarm is reset will be logged.</p>

ALARM OPERATION WITH HYSTERESIS & AUTOMATIC RESET

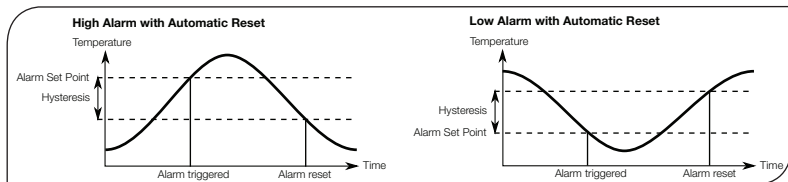

DATA LOGGING (-CRT AND -BRT MODELS)

The PyroMini can be used as a standalone data logger.

PyroMini models -CRT and -BRT include a MicroSD card slot for data logging, which can be configured via the touch screen interface. The user can select the sample rate and the number of samples to be taken and schedule the data logging to start at a certain time.

With a 2 GB card, the user can store 28.4 million readings, which provides almost 1 year's worth of data at the fastest possible sample rate of 1 per second.

Data is stored on the MicroSD card in .csv format and can be viewed and edited easily using spreadsheet software.







A MicroSD card with SD card adapter is available as an optional accessory.

The MicroSD card slot and battery holder are located on the touch screen circuit board in the lid of the PyroMini. Readings are time and date stamped using the sensor's internal clock. The clock is reset when the power is disconnected, or it will continue if the optional battery is fitted.

DATA LOGGING SPECIFICATIONS

Data Logging Interval	1 to 86,400 seconds (1 day)
MicroSD Card	Max. capacity: 2 GB (not included)
Internal Clock Battery	1 x BR 1225 3V (not included)
Variables Logged	Target temperature, sensing head temperature, electronics module temperature, max, min, average, emissivity setting, reflected energy compensation temperature
File format	.csv
Configurable Parameters	Sample period, number of samples, scheduled start date and time
Modbus address range	1 to 247

USING THE PYROMINI AS A DATA LOGGER

1. Insert a MicroSD card into the holder on the circuit board inside the lid of the PyroMini electronics module.
2. To retain the date and time when the PyroMini is switched off, fit a battery to the holder on the circuit board inside the lid.
3. Replace the lid and connect the sensor power supply.
4. To set the number of samples to be logged, the time period between samples, and, if required, to schedule data logging to automatically start, press  to access the Settings menu, then press  to access the Data Logging options.
5. To save data logging settings, press .
6. To manually start data logging, press  on the Temperature View or List View.
7. While logging is in progress, the logging icon  flashes on the Temperature View and List View.
8. To stop data logging, press .
9. To transfer data to a computer, remove the MicroSD Card from the sensor, insert the card into the SD Card adapter (supplied with MicroSD Card, accessory model MSD) and insert the adapter into an SD Card reader.

Note: MicroSDHC Cards are not compatible with the PyroMini.

INSTALLATION OF MICROSD CARD AND BATTERY

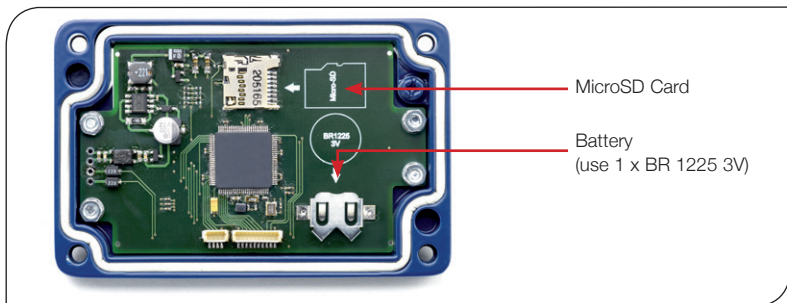

DATA LOG FILES

Data is saved to the MicroSD Card in .csv format. This file format can be opened or imported by spreadsheet software such as Microsoft Excel.

A new folder is created on the MicroSD Card for each day that data is logged.

A new log file is created every time logging is started. The start time is used as the file name.

DIMENSIONS

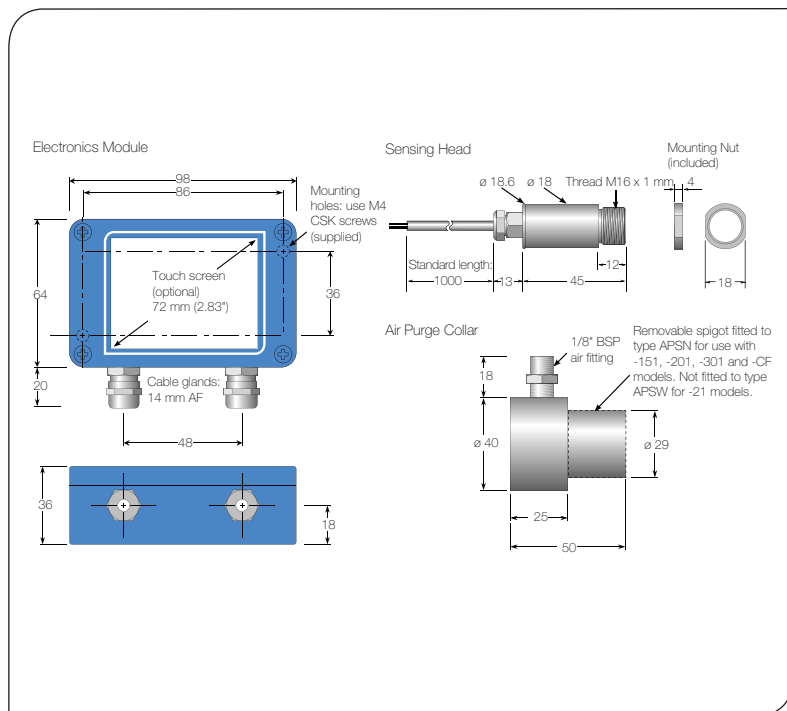

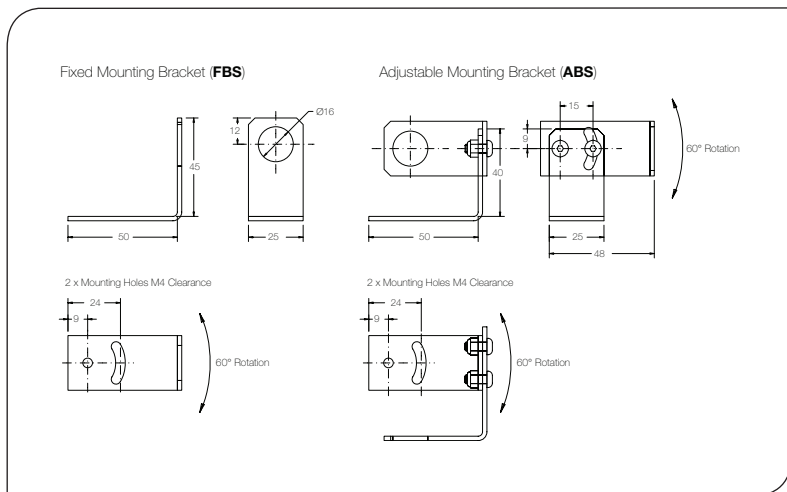

ACCESSORIES

A range of accessories to suit different applications and industrial environments is available. These may be ordered at any time and added on-site. The following accessories are available from Calex:

Fixed mounting bracket (see above for dimensions): Allows rotational adjustment in one dimension. Model number: FBS.

Adjustable mounting bracket (see above for dimensions): Allows rotational adjustment in two dimensions. Model number: ABS.

Air purge collar (see above for dimensions): The air purge collar is used to keep dust, fumes, moisture, and other contaminants away from the lens. It must be screwed fully onto the sensing head. Air flows into the 1/8" BSP fitting and out of the front aperture. Air flow should be 5 to 15 l/min. Clean or 'instrument' air is recommended. Model APSW is for use with sensors with 2:1 optics. Model APSN is for use with all other PyroMini models.

Laser sighting tool: When fitted to the sensor during installation or re-alignment, the laser sighting tool pinpoints the centre of the measured spot. Model number: LSTS.

MicroSD Card: Stores logged data. For use with -BRT and -CRT models. Includes SD Card adapter. Model number: MSD.

OPTIONS

The following options are available. Options are factory installed and must be ordered with the sensor.

Calibration Certificate: UKAS traceable certificate showing the measured temperature at three points across the sensor's temperature range. Model number: CALCERTA.

Extended Cable (30 m maximum total cable length): 1 m cable is supplied with each sensor as standard. Extra cable can be added to this in increments of 1 m. Model number: PMCE (-MA models), PMCEHT (-HA models).

INSTALLATION

The installation process consists of the following stages:

Preparation

Mechanical installation

Electrical installation

Please read the following sections thoroughly before proceeding with the installation.

PREPARATION

Ensure that the sensor is positioned so that it is focused on the target only.

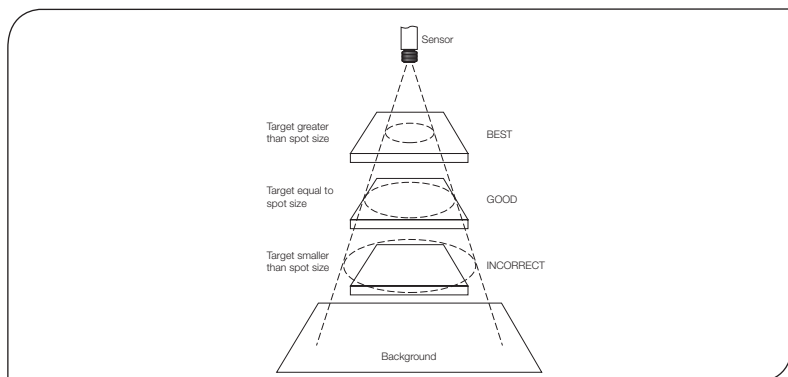

DISTANCE AND SPOT SIZE

The size of the area (spot size) to be measured determines the distance between the sensor and the target. The spot size must not be larger than the target. The sensor should be mounted so that the measured spot size is smaller than the target.

AMBIENT TEMPERATURE

The PyroMini is available with a choice of two miniature sensing heads, for use in low or high ambient temperatures:

-MA models: The sensing head is designed to operate in ambient temperatures from 0°C to 60°C.

-HA models: The sensing head is designed to operate in ambient temperatures from 0°C to 180°C. No cooling is required, which saves the energy and cost of supplying air or water to cool the sensor.

Avoid thermal shock. Allow 20 minutes for the unit to adjust to large changes in ambient temperature.

ATMOSPHERIC QUALITY

Smoke, fumes, dust or steam can contaminate the lens and cause errors in temperature measurement. In these types of environment the air purge collar should be used to help keep the lens clean.

INTERFERENCE FROM MOVEMENT

The low-noise sensing head cable on -HA models is resistant to interference caused by movement. The sensing head may be mounted on moving machinery such as robot arms without affecting the accuracy of the measured temperature.

ELECTRICAL INTERFERENCE

The PyroMini is tested to industrial standards for electromagnetic compatibility (EMC) as shown in Specifications at the beginning of this manual.

To minimise electromagnetic interference or 'noise', the sensor should be mounted away from motors, generators and such like.

POWER SUPPLY

Be sure to use a 24 V DC (100 mA) power supply.

MECHANICAL INSTALLATION

All sensors come with a 1 m cable and a mounting nut as standard. Longer cables are available to order. The sensor can be mounted on brackets or cut-outs of your own design, or you can use the fixed or adjustable mounting bracket accessories.

Note: The sensor housing must be connected to earth at one point, either the housing of the sensing head, the electronics module, or the output cable shield termination. To avoid ground loops, please ensure the sensor is grounded at only one of these points.

ELECTRICAL INSTALLATION

CONNECTIONS

-CB and -CRT models

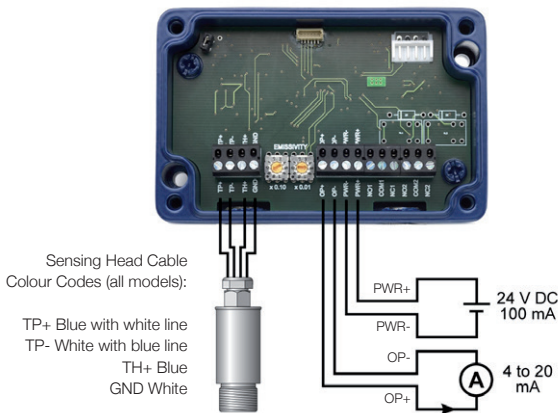

-BB and -BRT models

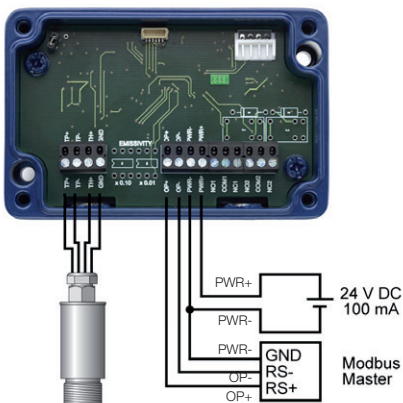

WIRING (ALL MODELS)

Check the distance between the sensing head and the electronics module, and between the electronics module and the instrumentation. If necessary, the sensor can be ordered with a longer cable between the sensing head and the electronics module.

The output cable from the electronics module should have an outer diameter between 3.0 and 6.5 mm, with conductors of size 28 to 18 AWG.

The terminal blocks in the electronics module may be removed from the circuit board for easy wiring.

Do not disconnect the touch screen circuit board from the main circuit board while the sensor is on.

WIRING (-BB AND -BRT MODELS)

When connecting several sensors in a single Modbus network, all of the sensors should be connected via a junction box to a single network bus cable, running from the furthest sensor to the Modbus Master.

Up to 247 sensors may be connected to a single Modbus network. Each sensor must have a unique Modbus address. PyroMini sensors are normally shipped with Modbus address 1. The Modbus address may be changed via the touch screen interface on -BRT models, or via Modbus.

To help prevent data reflections, please ensure the cable between each sensor and the main network bus is as short as possible. The network bus should be terminated with a resistor of 120Ω between the RS+ and RS- wires. The PWR- wire of the bus should be connected to the signal ground of the Modbus Master.

MODBUS OVER SERIAL LINE (RS485)

Interface

Baud rate	9600
Format	8 data, No parity, 1 stop bit
Reply delay (ms)	20

Supported functions

Read register	0x03, 0x04
Write single register	0x06
Write multiple register	0x10
Mask write register	0x16
Read/write	0x17

The list below includes all available addresses:

R = Read

W = Write (single, multiple or read/write)

MW = Mask write

Address	Length (words)	Description	R/W/MW
0x00	1	MODBUS slave address	R/W*
0x02	2	Sensor identification register Bits 0..19 - Serial number Bits 20..23 - Sensor type (12 = PyroMini) Bits 24..26 - Sensor field-of-view For MA : 0 = 2:1, 1 = 15:1, 2 = 30:1 For HA : 0 = 20:1 Bits 28..32 - Reserved	R

Address	Length (words)	Description	R/W/MW
0x06	1	Unfiltered object temperature	R
0x08	1	Sensor temperature	R
0x0A	1	Maximum temperature over hold period	R
0x0C	1	Minimum temperature over hold period	R
0x0E	1	Average temperature over hold period	R
0x10	1	Filtered object temperature	R
0x12	1	PCB temperature	R
0x14	1	Emissivity (1 LSB = 0.0001) Minimum 0.2000, Maximum 1.0000	R/W
0x16	1	Reflected temperature	R/W
0x18	1	Sensor status register Bits 0..1 - Reserved Bit 2 - Hold processing on (1)/off (0) Bit 3 - Hold peaks (1)/valleys (0) Bits 4..6 - Reserved Bit 7 - Reflected energy compensation on (1)/off (0) Bits 8..15 - Reserved	R/W/MW
0x1A	1	Average period (1 LSB = 0.05 seconds) Minimum 0.05 seconds, Maximum 60.00 seconds	R/W
0x1C	1	Hold period (1 LSB = 0.05 seconds) Minimum 0.05 seconds, Maximum 1200.00 seconds	R/W
0x1E	1	Temperature at 4 mA Minimum -20°C, Maximum 900°C	R/W
0x20	1	Temperature at 20 mA Minimum 80°C, Maximum 1000°C	R/W
0x22	1	Alarm 1 setpoint Minimum -20°C, Maximum 1000°C	R/W
0x24	1	Alarm 1 hysteresis Minimum 0°C, Maximum 1000°C	R/W
0x26	1	Alarm 1 status register Bit 0 – Relay triggered (R) Bit 1 – Visible alarm active (R) Bit 2 – Alarm triggered (R) Bit 3 – Auto reset (1)/manual reset (0) (R/W/MW) Bit 4 – Alarm acknowledge (R/W/MW) Bit 5 – Alarm reset (R/W/MW) Bits 6..7 – Reserved Bit 8 – High alarm (1)/low alarm (0) (R/W/MW) Bit 9 – Alarm enabled (1)/disabled (0) Bits 10..15 – Reserved	R/W/MW

Address	Length (words)	Description	R/W/MW
0x28	1	Alarm 2 status register Bit 0 – Relay triggered (R) Bit 1 – Visible alarm active (R) Bit 2 – Alarm triggered (R) Bit 3 – Auto reset (1)/manual reset (0) (R/W/MW) Bit 4 – Alarm acknowledge (R/W/MW) Bit 5 – Alarm reset (R/W/MW) Bit 6 – Reserved Bit 7 – Filtered object temperature (1)/head temperature (0) (R/W/MW) Bit 8 – High alarm (1)/low alarm (0) (R/W/MW) Bit 9 – Alarm enabled (1)/disabled (0) Bits 10..15 – Reserved	R/W/MW
0x2A	1	Alarm 2 setpoint Minimum -20°C, Maximum 1000°C	R/W
0x2C	1	Alarm 2 hysteresis Minimum 0°C, Maximum 1000°C	R/W

* Single register writes only. New address will not take effect until next power on.

Notes:

1. All temperatures are in tenths of degrees C
2. Writing to unlisted registers could cause malfunction
3. All write and mask operations are saved to non-volatile memory
4. For further information please refer to <http://www.modbus.org/specs.php>
5. Use address 255 to communicate with any connected sensor. Use address 0 to broadcast to all connected sensors (no response expected)

OPERATION

Once the sensor is in position and the appropriate power, air and cable connections are secure, the system is ready for continuous operation by completing the following simple steps:

1. Turn on the sensor power supply
2. Turn on the connected instrumentation
3. Read, monitor or log the temperature

IMPORTANT

Be aware of the following when using the sensor:

- If the sensor is exposed to significant changes in ambient temperature (hot to cold, or cold to hot), allow 20 minutes for the temperature to stabilise before taking or recording measurements.
- Do not operate the sensor near large electromagnetic fields (e.g. around arc welders or induction heaters). Electromagnetic interference can cause measurement errors.
- Wires must be connected only to the appropriate terminals.

VIEWING THROUGH A WINDOW

The PyroMini is capable of measuring the temperature of a target through a window made of a material that is transmissive to infrared radiation at 8-14 microns. The emissivity setting of the sensor should be adjusted to compensate for the presence of the window. Please contact Calex for more information on using the PyroMini with a window.

MAINTENANCE

Our customer service representatives are available for application assistance, calibration, repair, and solutions to specific problems. Contact our Service Department before returning any equipment. In many cases, problems can be solved over the telephone. If the sensor is not performing as it should, try to match the symptom below to the problem. If the table does not help, call Calnex for further advice.

Troubleshooting		
Symptom	Probable Cause	Solution
No output	No power to sensor	Check power supply
Erroneous temperature	Incorrect wire connection	Check wire colour codes
Erroneous temperature	Faulty sensor cable	Verify cable continuity
Erroneous temperature	Field of view obstruction	Remove obstruction

LENS CLEANING

Keep the lens clean at all times. Any foreign matter on the lens would affect measurement accuracy. Blow off loose particles (if not using the air purge accessory) with an air 'puffer'.

GUARANTEE

Calnex guarantees each instrument it manufactures to be free from defect in material and workmanship under normal use and service for the period of two years from the date of purchase. This guarantee extends only to the original buyer according to Calnex terms and conditions of Sale.

La série PyroMini est une gamme de mini-capteurs de température infrarouge avec électronique séparée.

Tous les modèles disposent d'un réglage d'émissivité et sont capables de mesurer une grande variété de matériaux : nourriture, papier, textiles, plastiques, cuir, tabac, produits pharmaceutiques, produits chimiques, caoutchouc, charbon et l'asphalte.

L'option écran tactile permet l'indication de température, les alarmes, la configuration du capteur et l'enregistrement des données sur carte MicroSD. L'option tête de détection haute température permet une utilisation à des températures ambiantes allant jusqu'à 180 ° C sans refroidissement. Sur les modèles haute température, les câbles supportent les déplacements pour des montages sur bras robot.

Un large choix d'optiques est disponible pour s'adapter aux tailles des cibles et aux distances de mesures. Les modèles disposent de sorties 4-20 mA, alarmes et RS 485 MODBUS.

SPÉCIFICATIONS

GÉNÉRALES

Plage de températures	Voir table des références
Étendue Maximum Temperature (-CRT models)	1020°C
Étendue Minimum Temperature (-CRT models)	100°C
Sorties	4-20 mA / RS485 Modbus
Champ de vision	Voir table des références
Précision	± 1% de la mesure ou ± 1°C, celui qui est le plus important
Fidélité	± 0,5% de la mesure ou ± 0,5°C, celui qui est le plus important
Plage de réglage d'émissivité	0.20 – 1.00
Méthode de réglage d'émissivité	Modèle -CB : 2 commutateurs rotatifs sur carte électronique Modèles -BB et -BT : via RS485 Modèles -CRT et -BT : via l'écran tactile
Temps de réponse, t90	240ms (réponse 90%)
Réponse spectrale	8 à 14µm
Voltage d'alimentation	24 V DC ± 5%
Courant d'appel Maximum	100 mA
Impédance en boucle maximale	Modèles -CB et -CRT: 900 Ω (4-20 mA sortie)
Alarmes relais (Modèle -CRT)	2 x relais simple inverseur 24 V DC, 1 A, isolation 500 V DC

MECANIQUE

	TETE	MODULE ELECTRONIQUE
MATIERE	INOX 316	Aluminium moulé sous pression
Dimensions	Ø18 x 45 mm	98(L) x 64(H) x 36(P) mm
Montage	M16 x 1 mm	2 vis M4 pour montage mural (voir schéma)

Câble (tête de mesure / électronique)	1 m (standard) jusqu'à 30 m (option)
Poids avec 1 m Cable	390 g (approx)
Raccordements	Bornier débrochable (voir schéma de raccordement) taille du conducteur 0.321 mm ²
Presse étoupe	Câble diametres 3.0 to 6.5 mm

ENVIRONNEMENT

	Capteur	Interface Electronique (sans écran)	Interface Electronique (avec écran)
Indice de protection	IP65 (NEMA 4)	IP65 (NEMA 4)	-
Température d'utilisation	Voir tableau des références	0°C à 60°C	0°C à 60°C
Humidité relative	Maximum 95% non condensée	Maximum 95% non condensée	Maximum 95% non condensée
CE	Oui	Oui	Oui
RoHS	Oui	Oui	Oui

COMPATIBILITÉ ÉLECTROMAGNÉTIQUE

Classe	Standard	Description
EMC	EN61326-1:2006	Appareil électrique de mesure, régulation et laboratoire – Industrie
- Immunité	IEC 61000-4-2	décharges électrostatiques
	IEC 61000-4-3	Champs électromagnétiques
	IEC 61000-4-4	Eclatement
	IEC 61000-4-5	Surtensions
	IEC 61000-4-6	Contrainte aux champs rayonnants
- Emissions	EN 55022A	RF Emissions Class A
	EN 55022B	RF Emissions Class B

DEFINITION DES RÉFÉRENCES

Les combinaisons suivantes sont disponibles sur les capteurs PyroMini:

Series	Température de fonctionnement du capteur	Champs de vue	Température de mesure	Sorties et Interface	
PM	MA	21 151 301 CF	LT MT HT XT	CB	
			CT	CRT BB BRT	
	HA		201	HT XT	CB
				CT	CRT BB BRT

TEMPÉRATURE DE FONCTIONNEMENT DU CAPTEUR

- MA** 0°C à 60°C
- HA** 0°C à 180°C

Le capteur type HA est capable de fonctionner sans refroidissement jusqu'à des températures ambiantes de 180°C. Valable avec une optique 20:1.

Il n'est pas nécessaire d'alimenter le capteur en air ou en eau, ce qui permet d'utiliser un capteur plus petit que ceux avec système de refroidissement.

FIELD OF VIEW

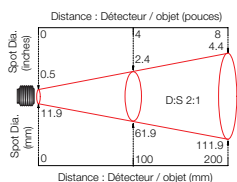

-21

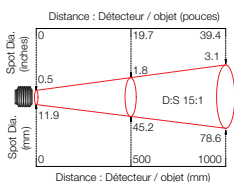

-151

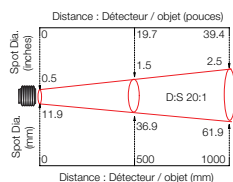

-201

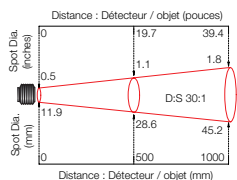

-301

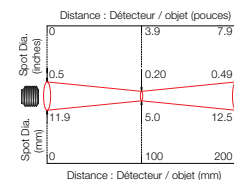

-CF

Diamètre du spot sur l'objet en fonction de la distance optique à 90 % d'énergie

TEMPÉRATURE DE MESURE (°C)

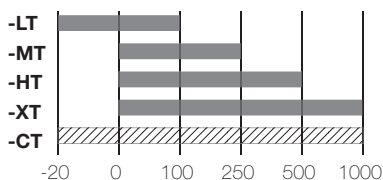

■ Fixe (exemple MT: 0°C à 4 mA, 250°C à 20 mA)

▨ Modèle CRT: Sortie 4 - 20 mA configurable

Modèles BRT and BB : Sortie numérique sur la pleine échelle

SORTIES ET INTERFACE

- CB** Sortie 4 - 20 mA, sans écran
- CRT** Sortie 4 - 20 mA output et 2 sorties alarmes relais, avec écran
- BB** Sortie RS485 Modbus, sans écran
- BRT** Sortie RS485 Modbus et 2 sorties alarmes relais, avec écran

EXAMPLE: PM-MA-301-CT-BRT

Series	Température de fonctionnement du capteur	Champs de vue	Température de mesure	Sorties et Interface
PM PyroMini	-MA 0°C à 60°C	-301 30:01	-CT configurable -20 à 1000 °C	-BRT Sortie RS485 Modbus et 2 sorties alarmes relais, avec écran

RÉGLAGE D'ÉMISSIVITÉ (MODÈLES CB)

Le réglage d'émissivité sur les modèles PyroMini-CB se fait via deux commutateurs rotatifs à l'intérieur du boîtier électronique. Réglage d'émissivité :

Pour le premier chiffre après la virgule (0.1), régler le commutateur gauche.

Pour le deuxième chiffre après la virgule (0.01), régler le commutateur droit.

Pour régler l'émissivité à 1.0, mettre les 2 commutateurs à zéro.

Le réglage d'émissivité minimale est de 0,2. Si un réglage plus faible émissivité est sélectionné, le capteur sera par défaut à un réglage d'émissivité de 0,95.

Exemples:

commutateur gauche	commutateur droit	Emissivité
6	3	0.63
0	0	1.00

ÉCRAN TACTILE (MODÈLES CRT ET BRT)



L'option écran tactile rétro-éclairé permet : l'affichage de la température mesurée, la configuration complète du capteur et l'affichage de l'historique des mesures.

En cas d'alarme, l'écran l'indique en changeant de couleur. Les modes et les niveaux d'alarmes sont configurés via l'écran.



SPECIFICATIONS DE L'ÉCRAN TACTILE



Format	2.83" (72 mm) dalle résistive, TFT, 320 x 240 pixels, rétro-éclairé
Paramètres configurables	Plage de température, unité, émissivité, compensation de l'énergie réfléctée, alarmes, Traitement du signal, adresse Modbus (modèles BRT), date et heure, enregistrement des données
Unité	°C or °F
Resolution	0.1°
Alarmes	2 alarmes avec réglage du seuil, configurables hautes ou basses. L'alarme 2 peut permettre la surveillance de la température interne du capteur.
Traitement du signal	Moyenne, Valeur pic, Valeur creux, minimum, maximum

INTERFACE UTILISATEUR

Affichage par défaut	Temperature
Sélection de l'unité  	Presser "°C" pour passer en °F Cette icône s'affiche lorsqu'une carte SD est insérée, et clignote lorsque la journalisation des données est en cours. Cette icône s'affiche lorsque l'enregistrement des données est programmé et prêt à démarrer.



	Affichage liste des températures
--	----------------------------------

 	Verrouillé/Déverrouillé Le mot de passe par défaut est 1234.
	Changer le mot de passe

 	Départ/Arrêt de l'enregistrement
--	----------------------------------

	Courbes
 	RAZ des courbes Défilement en temps réel de la mesure
	Acquittement des alarmes
	Réglages Appuyer sur  pour sauvegarder ou  pour quitter sans sauvegarde.

SETTINGS

	Date et heure
	Traitement du signal de sortie
Averaging Period Hold Mode Hold Period	Echantillonnage de la moyenne Mode mémoire: Peak - Pic Valley - Creux Off - Off Durée enregistrement



	Enregistrement de données
Sample Period	Période échantillonnage
Number of Samples	Nombre d'échantillons
Enable Scheduled Start	Programmation du début enregistrement
Date and Time	Date et heure

	Emissivité et Compensation
Emissivity Setting	Réglage émissivité
Enable Reflected Energy Compensation	Activation de compensation d'énergie Réfléctée
Reflected Temperature	Température réfléctée

	Sortie 4 - 20 mA (modèles CRT)
Temperature at 4 mA	Température à 4 mA
Temperature at 20 mA	Température à 20 mA

	Adresse Modbus (modèles BRT)
Modbus Address	Adresse

SETTINGS (continued)

	Alarmes
	Réinitialisation des alarmes

SETTINGS > ALARMS

	Alarme 1 et Alarme 2
Alarm Set Point	Réglage seuil
Hysteresis	Hystérésis
Filtered Temperature or Sensor Temperature (Alarm 2 only)	Temperature mesurée / température capteur (alarme 2)
Alarm Type	Alarms: High - Haute Low - Basse Off - Off
Reset	RAZ: Automatic - Automatique Manual - Manuelle

	Alarme sur enregistrement
Log Trigger Time	Tempo de départ enregistrement
Log Data While Triggered	Déclenchement enregistrement sur alarme
Log Acknowledge Time	Tempo acquittement alarme
Log Reset Time	Tempo RAZ enregistrement

ALARME AVEC HYSTÉRESIS ET RAZ AUTOMATIQUE

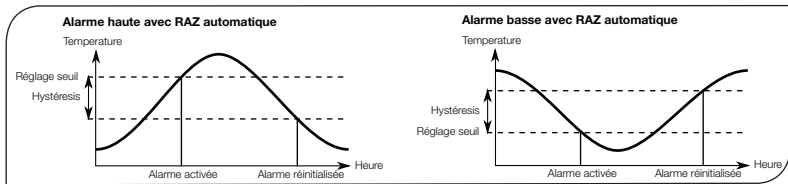

ENREGISTREMENT DE DONNÉES (-CRT ET -BRT)

La PyroMini peut être utilisée comme enregistreur de données autonome.

Les PyroMini CRT et BRT ont un slot pour MicroSD card. L'utilisateur peut paramétrer la période d'échantillonnage, la quantité d'échantillons et la date et heure de début d'enregistrement. Avec une carte de 2 Go, l'utilisateur peut stocker 28,4 millions de données, soit un an d'enregistrement avec une période d'échantillonnage de 1 seconde.

Les données sont stockées sur la carte MicroSD en format CSV et peuvent être visualisées et éditées facilement en utilisant un tableau.







Une carte MicroSD avec adaptateur de carte SD sont disponibles en option.

La fente pour carte microSD et le support de la batterie sont situés sur le circuit imprimé de l'écran tactile dans le couvercle de la PyroMini. Les enregistrements sont horodatés en utilisant l'horloge interne du capteur. Sans l'option batterie, l'horloge est réinitialisée lorsque l'appareil est débranché.

CARACTERISTIQUES DES ENREGISTREMENT

Enregistrement	1 à 86,400 secondes (1 jour)
MicroSD Card	Capacité max. : 2 GB (non incl.)
Sauvegarde horloge	1 x BR 1225 3V (non incl.)
Variables enregistrables	Température objet, température du capteur, température du module électronique, max, min, moyenne, Réglage émissivité, compensation température réfléchie
Format des fichiers	.csv
Paramètres configurables	Echantillonnage, nombre d'échantillons, programmation horodaté de l'enregistrement
Adresses Modbus	1 to 247

UTILISER LE PYROMINI COMME ENREGISTREUR

1. Insérez une carte microSD dans le logement prévu du circuit imprimé à l'intérieur du couvercle du PyroMini.
2. Installer la batterie de sauvegarde de l'horloge sur le circuit imprimé du couvercle.
3. Remplacez le couvercle et alimentez le capteur.
4. Pour définir le nombre d'échantillons, la période d'échantillonnage, et, si nécessaire, horodater le début automatique de l'enregistrement, pressez  pour accéder au menu de paramétrage, puis pressez  pour accéder aux options d'enregistrement.
5. Pour sauvegarder les paramètres d'enregistrement, pressez .
6. Pour démarrer manuellement l'enregistrement, pressez  sur l'affichage température ou liste.
7. En cours d'enregistrement, l'icône  clignote sur l'affichage température ou liste.
8. Pour arrêter l'enregistrement, pressez .
9. Pour transférer les données vers un ordinateur, retirez la MicroSD card du PyroMini, insérez-la dans l'adaptateur prévu à cet effet, et insérez l'ensemble dans le récepteur de l'ordinateur prévus à cet effet.

Note: Les MicroSDHC Cards ne sont pas compatibles avec le PyroMini.

INSTALLATION DE LA MICROSD CARD ET DE LA BATTERIE

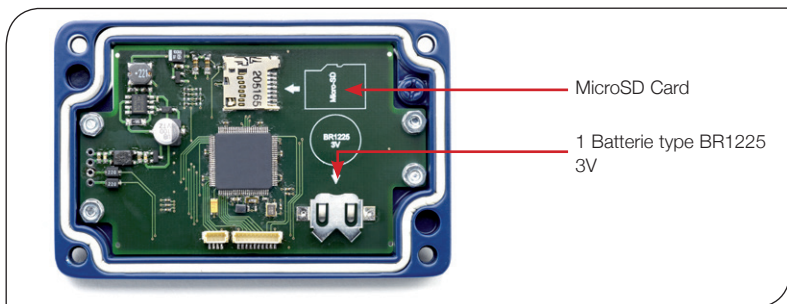

FICHIERS D'ENREGISTREMENTS

Fichiers d'enregistrements

Les données sont enregistrées sur la carte MicroSD en format CSV. Ce format de fichier peut être ouvert ou importé par un tableur type Microsoft Excel.

Un nouveau dossier est créé sur la carte MicroSD pour chaque jour où les données sont enregistrées.

Un nouveau fichier est créé chaque fois que la journalisation commence. L'heure de début est utilisé comme nom de fichier.

DIMENSIONS

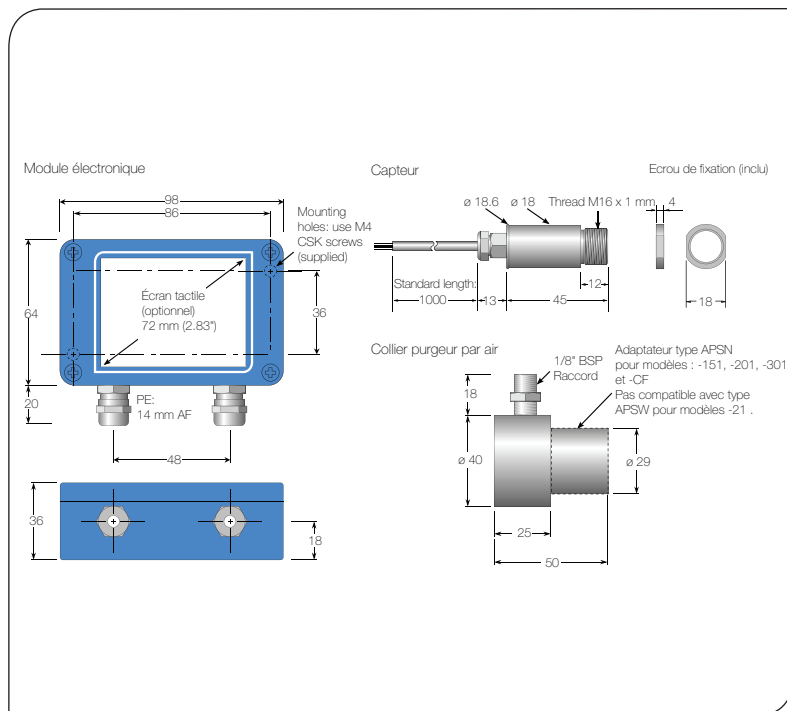

Support de montage fixe (FBS)

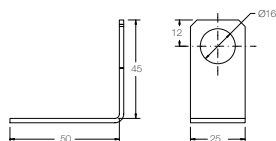

Support de fixation réglable (ABS)

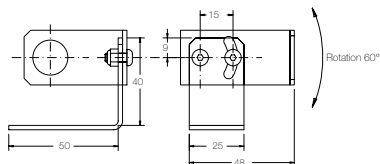

Montage trous: M4

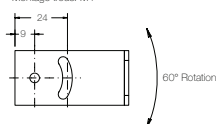

Montage trous: M4

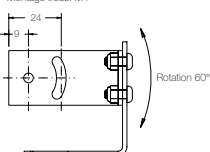

ACCESSOIRES

Une gamme d'accessoires pour s'adapter aux applications et environnements industriels est disponible chez CALEX. Ils peuvent être commandés à tout moment et ajoutés sur l'application existante.

Support de montage fixe (voir ci-dessus pour les dimensions): Permet le réglage en rotation dans une seule dimension. Numéro de modèle: FBS.

Support de fixation réglable (voir ci-dessus pour les dimensions): Permet le réglage de rotation en deux dimensions. Numéro de modèle: ABS.

Purgeur à air (voir ci-dessus pour les dimensions): Le collier de purge d'air est utilisé pour protéger l'optique de la poussière, des fumées, de l'humidité et des autres contaminants. Il doit être vissé à fond sur la tête de détection. L'air circule dans le raccord 1/8" BSP et hors de l'ouverture frontale. Le débit d'air doit être de 5 à 15 l / min. De l'air pur ou «instrument» est recommandé. Le modèle APSW est à utiliser avec des capteurs à optique 02h01 . Le modèle APSN est à utiliser avec tous les autres modèles PyroMini .

Visée laser : Montée sur le capteur lors de l'installation ou de ré-alignements, la visée laser permet d'identifier le centre du spot de mesure. Référence : LSTS.

MicroSD Card: Pour l'enregistrement de données. à utiliser avec les modèles BRT-et-CRT . Comprend l'adaptateur SD Card. Référence : MSD.

OPTIONS

Les options suivantes sont disponibles. Les options sont installées en usine et doivent être commandées avec le capteur.

Certificat d'étalonnage: certificat de traçabilité UKAS indiquant la température mesurée sur trois points de l'étendue de mesure du capteur. Référence : CALCERTA.

Câble supplémentaire (30 m maximum au total): 1 m de câble est fourni avec chaque capteur en standard. Le câble supplémentaire peut être ajouté par incréments de 1 m. Référence: PMCE (modèles MA), PMCEHT (modèles HA).

INSTALLATION

Le processus d'installation consiste aux étapes suivantes :

Préparation

Installation mécanique

Installation électrique

Il faut lire les sections suivantes attentivement avant de commencer l'installation.

PRÉPARATION

S'assurer que le détecteur est mis en place pour qu'il ne se concentre que sur la cible.

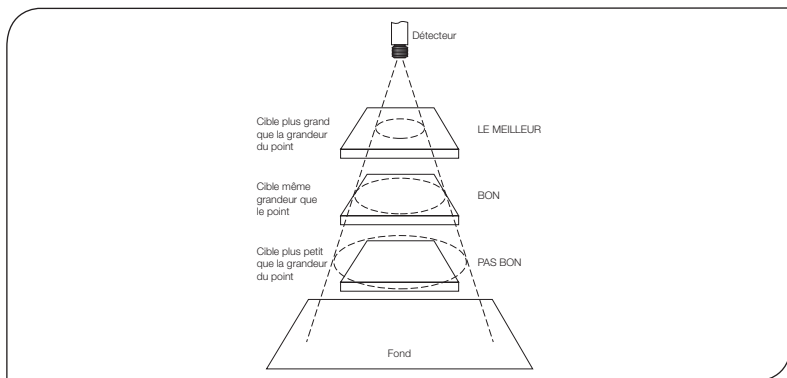

DISTANCE ET TAILLE DU POINT

La taille de la zone (taille du point) qui doit être mesurée détermine la distance entre le détecteur et la cible. La taille du point ne doit pas être plus grande que la cible. Le détecteur devrait être monté de façon à ce que la taille du point mesuré est plus petite que la cible.

TEMPERATURE AMBIANTE

Le PyroMini est disponible avec un choix de deux têtes de détection miniatures pour une utilisation basse ou haute température ambiante :

- **Modèles MA** : La tête de détection est conçu pour fonctionner à des températures ambiantes de 0 ° C à 60 ° C.
- **Modèles HA** : La tête de détection est conçu pour fonctionner à des températures ambiantes de 0 ° C à 180 ° C. Aucun refroidissement n'est nécessaire (économie d'installation et d'énergie).

Eviter les chocs thermiques. Allouer 20 minutes au thermomètre, pour qu'il s'adapte à d'importantes fluctuations de température ambiante.

QUALITÉ ATMOSPHÉRIQUE

La fumée, les vapeurs ou la poussière peuvent contaminer la lentille et provoquer des erreurs dans la mesure de température. Dans ces genres d'environnement, le collier de purge d'air devrait être utilisé pour aider à garder la lentille propre.

VIBRATIONS

Le Câble de la tête sur HA-modèles est résistant aux interférences provoquées par les vibrations. La tête de capteur peut être montée sur des machines en mouvement tels que des bras de robot, sans affecter la précision de la température mesurée.

ELECTRICAL INTERFERENCE

Le PyroMini est testé selon les normes industrielles en matière de compatibilité électromagnétique (CEM) - voir spécifications au début de ce manuel.

INTERFÉRENCE ÉLECTRIQUE

Pour réduire l'interférence électromagnétique ou 'bruit', le détecteur devrait être monté à l'écart de moteurs, générateurs, et autres appareils similaires.

ALIMENTATION

Veillez à utiliser un bloc d'alimentation DC 24 V (100 mA).

INSTALLATION MÉCANIQUE

Tous les détecteurs sont fournis avec un câble d'un mètre et un boulon de fixation. Des câbles plus longs sont disponibles à la commande. Le détecteur peut être monté sur un support ou sur des découpes de votre propre conception ou bien les accessoires de support fixe et réglable, qui sont montrés ci-dessous, peuvent être utilisés.

Nota: Il faut que le détecteur soit connecté à la terre à un seul point, soit au blindage du câble, soit au boîtier du détecteur. Pour éviter les retours de masse, assurez vous que le capteur est mis à la terre à une seule extrémité.

ELECTRICAL INSTALLATION

CONNECTIONS

Modèles -CB et -CRT

Les fils du câble du capteur sont repérés par code couleur (tous modèles):
 TP+ : Bleu et ligne blanche
 TP- : Blanc et ligne bleue
 TH+ : Bleu
 GND : Blanc

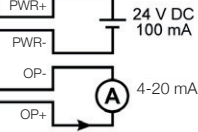
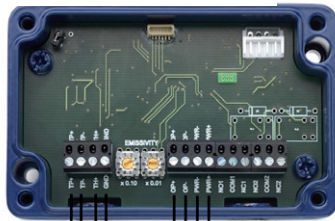

Modèles -BB et -BRT

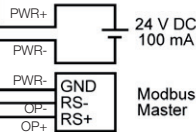
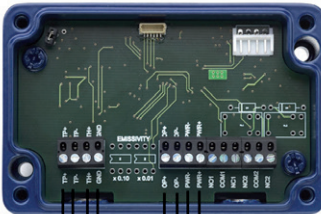

CÂBLAGE (TOUS MODÈLES)

Vérifier la distance entre la tête de capteur et le module électronique, et entre le module électronique et l'instrumentation. Si nécessaire, le capteur peut être commandé avec un câble plus long entre la tête de mesure et le module électronique.

En sortie du module électronique le câble doit avoir un diamètre extérieur compris entre 3,0 et 6,5 mm, avec des conducteurs de 0.321 mm² à 1.02 mm².

Les borniers du module électronique sont débroschables.

Ne débranchez pas le circuit imprimé de l'écran tactile de la carte de circuit principale tandis que le capteur est sous tension.

CABLAGE (MODÈLES BB ET BRT)

Lorsque plusieurs capteurs sont connectés sur une réseau MODBUS, ils doivent être raccordés via des boîte de jonction sur un bus unique allant du Maître à l'esclave le plus éloigné.

247 capteurs peuvent être connectés à un seul réseau Modbus. Chaque capteur doit avoir une adresse Modbus unique. Les capteurs PyroMini sont normalement livrés avec l'adresse Modbus 1. L'adresse Modbus peut être modifiée via l'interface écran tactile sur les modèles BRT ou via Modbus.

Pour éviter le parasitage des données, assurez vous que le câble entre chaque capteur et le bus principale soit le plus court possible. Une résistance terminale de 120Ω doivent être installées entre le RS+ et RS- en extrémité de bus. Le fils PWR du bus doit être connecté à la masse du maître Modbus.

MODBUS SUR LIAISON SÉRIÉ

Interface

Baud rate	9600
Format	8 bits de données, pas de bit de parité, 1 bit de stop
Délai de réponse (ms)	20

Supported functions

Lire registre	0x03, 0x04
Écriture d'un seul registre	0x06
Écrire multiple registre	0x10
Écriture masquée registre	0x16
Lire / écrire	0x17

Liste des adresses disponibles :

R = Lecture, W = Ecriture, MW = Ecriture masquée

Adresse	Longueur (mots)	Description	R/W/MW
0x00	1	Adresse MODBUS esclave (1 to 247)	R/W*
0x02	2	Registre identification capteur Bits 0..19 - Numéro de série Bits 20..23 - Type de capteur (12 = PyroMini) Bits 24..26 - champs de vue Pour MA : 0 = 2:1, 1 = 15:1, 2 = 30:1 Pour HA : 0 = 20:1 Bits 27..32 - Reserved	R

Adresse	Longueur (mots)	Description	R/W/MW
0x06	1	Température objet non filtrée	R
0x08	1	Température du capteur	R
0x0A	1	Température Maximum sur la période d'acquisition	R
0x0C	1	Température Minimum sur la période d'acquisition	R
0x0E	1	Température Moyenne sur la période d'acquisition	R
0x10	1	Filtre de temperature objet	R
0x12	1	Température PCB	R
0x14	1	Émissivité (1 LSB = 0.0001) Minimum 0.2000, Maximum 1.0000	R/W
0x16	1	Température réfléchie	R/W
0x18	1	Registre d'état du capteur Bits 0..1 - Reservé Bit 2 - Acquisition en cours on (1)/off (0) Bit 3 - Mémorisation pics (1)/creux (0) Bits 4..6 - Reservé Bit 7 - Compensation de l'énergie réfléchie on (1)/ off (0) Bits 8..15 - Reservé	R/W/MW
0x1A	1	Période d'échantillonnage pour la moyenne (1 LSB = 0.05 seconds) Minimum 0.05 seconds, Maximum 60.00 sec	R/W
0x1C	1	Période d'acquisition (1 LSB = 0.05 seconds) Minimum 0.05 sec Maximum 1200.00 sec	R/W
0x1E	1	Température à 4 mA Minimum -20°C, Maximum 900°C	R/W
0x20	1	Température à 20 mA Minimum 80°C, Maximum 1000°C	R/W
0x22	1	Alarme 1 seuil Minimum -20°C, Maximum 1000°C	R/W
0x24	1	Alarme 1 hysteresis Minimum 0°C, Maximum 1000°C	R/W
0x26	1	Alarme1 registre d'état Bit 0 – alarme active (R) Bit 1 – Alarme visuelle active (R) Bit 2 – alarme active (R) Bit 3 – RAZ auto (1)/RAZ manuelle (0) (R/W/ MW) Bit 4 – Alarme acquitée (R/W/MW) Bit 5 – RAZ alarme (R/W/MW) Bits 6..7 – Reservé Bit 8 – Alarme hte (1)/ alarme bas (0) (R/W/MW) Bit 9 – Alarme autorisée (1)/non autorisée (0) Bits 10..15 – Reservé	R/W/MW

Adresse	Longueur (mots)	Description	R/W/MW
0x28	1	Alarm 2 registre d'état Bit 0 – alarme active (R) Bit 1 – Alarme visuelle active (R) Bit 2 – alarme active (R) Bit 3 – RAZ auto (1)/RAZ manuelle (0)(0) (R/W/MW) Bit 4 – Alarme acquitée (R/W/MW) Bit 5 – RAZ alarme (R/W/MW) Bit 6 – Reservé Bit 7 – Température objet (1)/température capteur (0) (R/W/MW) Bit 8 – Alarme hte (1)/ alarme bas (0) (R/W/MW) Bit 9 – Alarme autorisée (1)/non autorisée (0) Bits 10..15 – Reservé	R/W/MW
0x2A	1	Alarme 2 seuil Minimum -20°C, Maximum 1000°C	R/W
0x2C	1	Alarme 2 hysteresis Minimum 0°C, Maximum 1000°C	R/W

* Ecriture registre simple seule. Nouvelle adresse prise en compte à la mise sous tension.

Notes:

1. Toutes les températures sont en dixièmes de degrés C
2. L'écriture dans les registres réservés ou non listé peut être cause de dysfonctionnement
3. Les écritures et opérations masquées sont sauvegardées en mémoire non volatile
4. Pour toutes informations complémentaires <http://www.modbus.org/specs.php>
5. L'adresse 255 permet de communiquer avec n'importe quel capteur. L'adresse 0 permet une diffusion multiple (pas de réponse en retour)

FONCTIONNEMENT

Lorsque le détecteur est en place et que les connexions appropriées d'alimentation, d'air, d'eau et de câbles sont bien fixées, le système est prêt pour fonctionner en continu en complétant les simples étapes suivantes :

1. Mettre le capteur sous tension
2. Connection à l'instrumentation
3. Lecture, surveillance, enregistrement

IMPORTANT

Il faut faire attention aux suivants lors de l'utilisation du détecteur :

- Si le détecteur est exposé à des changements significatifs de température ambiante (chaud à froid, ou froid à chaud), avant de prendre ou d'enregistrer des mesures attendre 20 minutes que la température se stabilise.
- Ne pas faire fonctionner le détecteur près d'importants champs électromagnétiques (par exemple autour d'un arc de soudage ou d'appareils chauffants à induction). Des interférences électromagnétiques peuvent provoquer des erreurs de mesure.
- Le câble ne doit être relié qu'à des terminaux appropriés.

MESURE DE TEMPERATURE VIA CAPOT DE PROTECTION

La PyroMini est capable de mesurer la température d'une cible à travers un capot constituée d'un matériau transparent au rayonnement infrarouge à 8-14 microns. Le réglage d'émissivité du capteur doit être ajustée pour compenser la présence de la fenêtre plastique. Contacter Calnex pour plus d'informations sur l'utilisation du PyroMini avec un capot de protection.

ENTRETIEN

Les représentants du service clientèle sont disponibles pour aider, calibrer, réparer et résoudre des problèmes particuliers. Contacter le service technique avant de retourner l'équipement. Dans beaucoup de cas, les problèmes peuvent être résolus par téléphone. Si le détecteur ne fonctionne pas comme il le devrait, essayer de faire correspondre le symptôme ci-dessous au problème. Si le tableau n'aide pas, appeler Calnex pour plus de renseignement.

Diagnostic de défaillances		
Symptôme	Cause probable	Solution
Pas de sortie	Pas d'alimentation au détecteur	Vérifier l'alimentation électrique
Température erronée	Connexion incorrecte du câble	Vérifier les codes de couleurs du câble
Température erronée	Câble du détecteur défaillant	Vérifier la continuité du câble
Température erronée	Obstruction champs de vue	Retirer l'obstruction

NETTOYAGE DE LA LENTILLE

Garder la lentille propre à tout moment. Toute matière étrangère sur la lentille affecterait la précision de la mesure. Souffler les particules libres (si l'accessoire de purge d'air n'est pas utilisé) avec un 'soufflet'.

GARANTIE

Calnex garantit que tous les instruments qu'il fabrique sont exempts de défauts ou de vices de fabrication dans des conditions normales d'utilisation et de service, pour une période de deux ans, à compter de la date d'achat. Cette garantie ne s'applique qu'à l'acheteur d'origine selon les conditions de vente de Calnex.

Die PyroMini Serie besteht aus mehreren berührungslos arbeitenden Infrarot Miniatur-Sensoren (Pyrometern) mit separaten elektronischen Komponenten.

Alle Modelle aben einen einstellbaren Emissionsgrad und können sehr verschiedene Materialien einschließlich Lebensmitteln, Papier, Textilien, Kunststoffe, Leder, Tabak, pharmazeutische Produkte Chemikalien, Gummi Kohle und Asphalt messen.

Das optionale Touchscreen Interface stellt die Temperaturinformation, Alarme, Sensoreinstellungen Datenspeicherungen (Datalogging) auf eine MicroSD Card zur Verfügung.

Verschiedene Optiken sind verfügbar um kleine oder grosse Ziele bei kurzen oder weiten Entfernungen zu messen. Man kann zwischen 4-20 mA, RS485 Modbus und Alarmrelais-Ausgängen wählen.

SPEZIFIKATION

ALLGEMEINES

Temperaturbereich	siehe Tabelle der verschiedenen Modelle
Maximaler Temperaturbereich (-CRT modelle)	1020°C
Minimaler Temperaturbereich (-CRT modelle)	100°C
Ausgang	4 bis 20 mA oder RS485 Modbus
Sichtfeld	siehe Tabelle der verschiedenen Modelle
Messunsicherheit	±1% des Messwerts oder ±1°C (je nachdem, welcher Wert größer ist)
Wiederholgenauigkeit	±0,5% des Messwerts oder ±0,5°C (je nachdem, welcher Wert größer ist)
Emissionsgrad-Einstellungsbereich	0.20 bis 1.00
Emissionsgrad-Einstellungsmethode	-CB Modelle: mit 2 Drehschaltern im Elektronik-Modul -BB und -BT Modelle: mit RS485 -CRT und -BT Modelle: mit dem Touchscreen
Reaktionszeit	240ms (90% Reaktion)
Spektralempfindlichkeit	8 bis 14µm
Speisespannung	24V Gleichstrom +/- 5%
Maximale Stromaufnahme	100 mA
Maximale Kreis-Impedanz	900 Ohm (4-20mA Leistung)
Alarm-Relais (CRT-Modelle)	2 x Single Pole Changeover Alarmrelais bewertet 24VDC, 1A, isoliert 500 V DC

MECHANIK

	Messkopf	Elektronik
Konstruktion	Edelstahl 316	Aluminiumguss
Hauptabmessungen	Ø18 x 45 mm	98 x 64 x 36 mm
Befestigung	M16 x 1 mm	zwei M4 Schrauben zur Wandbefestigung

Kabellänge (Sensorkopf - Elektronik)	1m (Standard), optional bis zu 30 m
Gewicht mit 1 m Kabel	ca. 390 g
Kabelverbindungen	zu öffende Schraubverbindungen (siehe Verbindungen) Leiterquerschnitt Cu 0,09 bis 1,0 mm ²
Kabelverschraubung	für Kabeldurchmesser von 3,0 bis 6,5 mm

UMWELTBESTIMMUNGEN

	Sensorkopf	Elektronik (ohne Touchscreen)	Elektronik (mit Touchscreen)
Schutzart	IP65 (NEMA 4)	IP65 (NEMA 4)	
Umgebungstemperaturbereich	siehe Tabelle der einzelnen Modelle	0°C bis 60°C	0°C bis 60°C
Relative Feuchte	max. 95% nicht kondensierend	max. 95% nicht kondensierend	max. 95% nicht kondensierend
CE-Zeichen	Ja	Ja	Ja
RoHS konform	Ja	Ja	Ja

ELEKTROMAGNETISCHE KOMPATIBILITÄTSSTANDARDS:

Klasse	Standard	Beschreibung
EMC Directive	EN61326-1:2006	elektrische Komponenten zur Messung, Kontrolle und Laboranwendung
- Unanfälligkeit	IEC 61000-4-2	Sicherheit gegen elektrostatische Entladungen
	IEC 61000-4-3	Sicherheit gegen elektromagnetische Felder
	IEC 61000-4-4	Bruchsicherheit
	IEC 61000-4-5	Drucksicherheit
	IEC 61000-4-6	Sicherheit gegen HF Störungen
- Emissions	EN 55022A	HF Emissionsklasse A
	EN 55022B	HF Emissionsklasse B

MODELL TYPBEZEICHNUNGEN

Folgende Kombinationen von Umgebungstemperaturen, Optiken, zu messendem Temperaturbereich, Ausgang und Interface sind für die PyroMini verfügbar:

Serien	Arbeitstemperaturbereich des Messkopfes	Sichtfeld	Messtemperaturbereich	Ausgang und Interface
PM	MA	21 151 301 CF	LT MT HT XT	CB
			CT	CRT BB BRT
	HA		HT XT	CB
			CT	CRT BB BRT

ARBEITSTEMPERATURBEREICH DES MESSKOPFES

- MA 0°C bis 60°C
- HA 0°C bis 180°C

Der Temperaturmesskopf für hohe Umgebungstemperaturen der -HA-Typen kann bei Temperaturen bis zu 180°C ohne Kühlung arbeiten.

Kühlluft oder Wasser sind nicht notwendig; der Miniaturmesskopf ist wesentlich kleiner als platzraubende, gekühlte Pyrometer.

FIELD OF VIEW

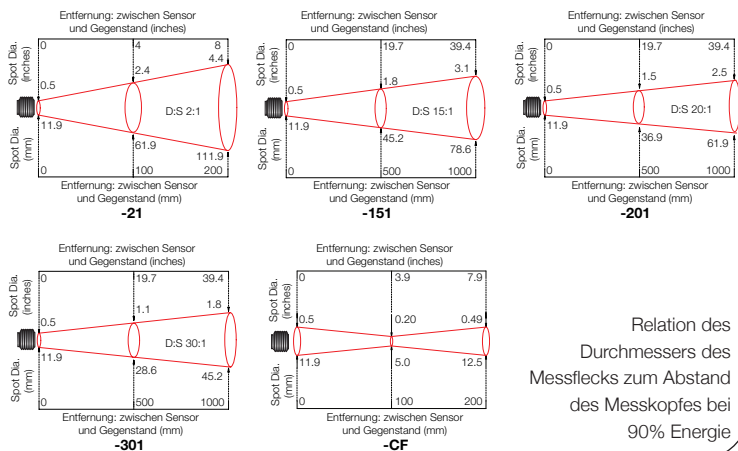

MEASUREMENT TEMPERATURE RANGE (°C)

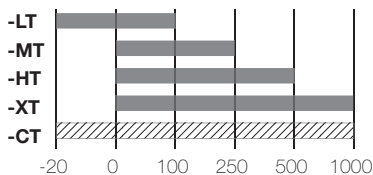

- Fixed (z.B. -MT: 0°C bei 4 mA, 250°C bei 20 mA)
- ▨ -CRT Typen: 4 bis 20 mA konfigurierbar innerhalb dieses Bereichs
- BRT und -BB Typen: Digitaler Ausgang, vollständiger Temperaturbereich

AUSGANG UND INTERFACE

- CB 4 bis 20 mA Ausgang, kein Touchscreen
- CRT 4 bis 20 mA Ausgang und zwei Relaisausgänge, mit Touchscreen
- BB RS485 Modbus Ausgang, kein Touchscreen
- BRT RS485 Modbus Ausgang und zwei Alarm-Relaisausgänge, mit Touchscreen

BEISPIEL: PM-MA-301-CT-BRT

Serien	Arbeitstemperaturbereich des Messkopfes	Sichtfeld	Messtemperaturbereich	Ausgang und Interface
PM PyroMini	-MA 0°C bis 60°C	-301 30:1 divergent	-CT 4 bis 20 mA konfigurierbar innerhalb dieses Bereichs: -20°C bis 1000°C	-BRT RS485 Modbus Ausgang und zwei Alarm- Relaisausgänge, mit Touchscreen

EMISSIONSGRADEINSTELLUNG (-CB TYPEN)

Die Emissionsgradeinstellung der PyroMini -CB Typen kann mit zwei Drehschaltern in der Elektronik eingestellt werden. Das geschieht folgendermaßen:

Stellen Sie den linken Schalter auf das erste Digit nach dem Dezimalpunkt (0.1)

Stellen Sie den rechten Schalter auf das zweite Digit nach dem Dezimalpunkt (0.1)

Um einen Emissionswert von 1.00 einzustellen, setzen Sie beide Schalter auf 0.

Die minimal mögliche Einstellung für den Emissionsgrad ist 0.2. Wenn eine kleinere Emissionsgradeinstellung (falsch) gewählt wird, wird der Sensor so anzeigen, als wäre 0.95 eingestellt.

Zum Beispiel:

Linker Schalter	Rechter Schalter	Emissionsgradeinstellung
6	3	0.63
0	0	1.00

TOUCH SCREEN (-CRT UND -BRT TYPEN)



Das optionale, hinterleuchtete Touchscreen-Interface, welches in der Abdeckung der Elektronik befestigt ist, stellt sowohl eine große, helle Anzeige der gemessenen Temperatur als auch Optionen den Sensor zu konfigurieren zur Verfügung. Die Kennlinienansicht zeigt den zeitlichen Verlauf der gemessenen Temperatur

Im Fall von Alarmen ändert das Display die Farbe um Alarme sofort und deutlich darzustellen. Alarmarten und Grenzwerte können mittels Touchscreen konfiguriert werden.



TOUCH SCREEN SPECIFICATIONS



Touchscreen Größe	72 mm Resistive touch TFT, 320 x 240 Pixel, hinterleuchtet
Konfigurierbare Parameter	Temperaturbereich, Temperatureinheiten, Emissionsgradeinstellung, Kompensation der reflektierten Energie, Alarme, Signalaufbereitung, Modbus Adressen (-BRT Typen), Datum und Zeit, Datenspeicherung
Temperatureinheiten	°C oder °F einstellbar
Temperaturaufösung	0.1°
Alarminstellung	zwei Alarme mit einstellbarer Schwelle, individuell einstellbar als HI (hoch) und LO (tief). Alarm 2 kann auf die zu messende Objekttemperatur oder die Eigentemperatur des Messkopfes eingestellt werden
Signalverarbeitung	Durchschnitt, einmalige Spitzenwertspeicherung (peak hold) , Minimalwertspeicherung (valley hold), Minimalwert, Maximalwert



BENUTZER INTERFACE

Voreingestellter Wert	Temperaturwert
Einstellung der Temperatureinheiten  	<p>Drücken Sie „°C“ um zwischen „°F“ zu wechseln und umgekehrt. Die Einheiten können durchgehend im Interface geändert werden.</p> <p>MicroSD Card eingesteckt</p> <p>Vorgesehene Datenspeicherung freigegeben</p>



	Liste der Temperaturen
Filtered Temp:	Gefiltert Temperatur
Unfiltered temp	Ungefiltert Temperatur
Average temp	Durchschnittstemperatur
Maximum temp	Maximale Temperatur
Minimum temp	Minimale Temperatur
Sensor temp	Temperatur der Messkopf
Reflected temp	Reflektierte Temperatur

 	<p>Sperren und Entsperren</p> <p>Das voreingestellte Passwort lautet 1234.</p>
	<p>Passwortänderung</p>

 	<p>Start Datenspeicherung</p> <p>Stop Datenspeicherung</p>
--	--

	<p>Temperaturkurve</p>
 	<p>Setzen Sie den Graph</p> <p>Echtzeitanzeige</p>

	<p>Alarmer quittieren</p>
---	---------------------------

	<p>Einstellungen</p> <p>Drücken Sie  um die Einstellungen zu sichern oder  um den Bildschirm ohne Sicherung zu verlassen.</p>
---	--

EINSTELLUNGEN

	Datum & Zeit
---	-------------------------

	Aufbereitung des Ausgangssignals
Averaging Period	Zeit zur Mittelwertberechnung
Hold Mode	Haltemodus: Peak - Spitze Valley - Tal Off - Aus
Hold Period	Zeitraum von halten



	Datenspeicherung
Sample Period	Speicherdauer
Number of Samples	Anzahl der Messwerte
Enable Scheduled Start	Geplanten Start freigeben
Date and Time	Datum und Zeit

EINSTELLUNGEN

	Emissionsgrad und Kompensation
Emissivity Setting Enable Reflected Energy Compensation Reflected Temperature	Emissionsgradeinstellung Freigabe zur Kompensation der reflektierten Energie Temperatur des reflektierte Energie

	4 bis 20 mA Ausgabe (-CRT-Modelle)
Temperature at 4 mA Temperature at 20 mA	Temperatur bei 4 mA Temperatur bei 20 mA

	Modbus-Adresse (-BRT-Modelle)
Modbus Address	Modbus-Adresse

	Alarme
	Alarme manuell zurücksetzen

EINSTELLUNGEN > ALARME

	Alarm 1 und Alarm 2
Alarm Set Point	Eingestellter Alarmauslösepunkt
Hysteresis	Hysterese
Filtered Temperature or Sensor Temperature (Alarm 2 only)	Gefilterte Temperatur oder Sensortemperatur (nur Alarm 2)
Alarm Type	Alarmtyp High - Obergrenze Low - Untergrenze Off Aus
Reset	Zurücksetzen Automatic – Automatisch Manual – Manuell

	Alarmaufzeichnung
Log Trigger Time	Auslösungszeit aufzeichnen
Log Data While Triggered	Daten bei Auslösung aufzeichnen
Log Acknowledge Time	Zeit, zu der der Alarm quittiert wurde, aufzeichnen
Log Reset Time	Zurücksetzungszeit des Alarms aufzeichnen

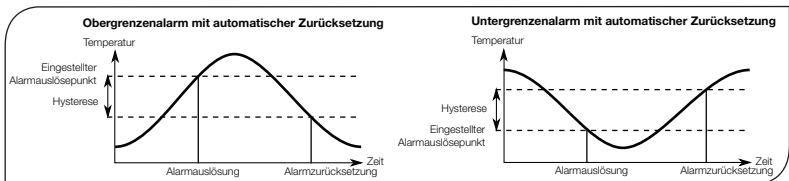
ALARMBETRIEB MIT HYSTERESE & AUTOMATISCHEM ZURÜCKSETZEN

DATEN-AUFZEICHNUNG (-CRT UND -BRT MODELLE)

Der PyroMini kann als unabhängiges Datenaufzeichnungsgerät verwendet werden.

Die PyroMini-Modelle -CRT und -BRT beinhalten einen Steckplatz für MicroSD-Karten zur Datenaufzeichnung. Dieser kann über die Touchscreen-Oberfläche konfiguriert werden.

Der Benutzer kann die Probenrate und die Anzahl der aufzunehmenden Proben auswählen und einen bestimmten Zeitpunkt für den Beginn der Datenaufzeichnung ansetzen.

Mit einer 2GB-Karte kann der Benutzer 28,4 Millionen Ablesungen speichern, was bei der schnellsten möglichen Probenrate von 1 Probe pro Sekunde Daten von der Dauer eines Jahres entspricht.

Daten werden auf der MicroSD-Karte im Format .csv gespeichert und können mit Tabellenkalkulationsprogrammen einfach angesehen und bearbeitet werden.

Eine MicroSD-Karte mit Adapter ist als optionales Zubehör verfügbar.

Der Steckplatz für MicroSD-Karten und die Batteriehalterung befinden sich auf der Platine des Touchscreens im Deckel des PyroMini.

Die Ablesungen werden unter Verwendung der internen Uhr mit Zeit und Datum versehen.

Wenn die Stromzufuhr unterbrochen wird, wird die Uhr zurückgesetzt. Wenn die optionale Batterie eingesetzt wird, läuft die Uhr weiter.

SPEZIFIKATIONEN FÜR DIE DATENAUFZEICHNUNG

Datenaufzeichnungs-Intervall 1 bis 86.400 Sekunden (1 Tag)

MicroSD-Karte Maximalkapazität: 2 GB (nicht enthalten)

Batterie für die interne Uhr 1 x BR 1225 3V (nicht enthalten)







Aufgezeichnete Variablen Zieltemperatur, Temperatur des Sensorkopfes, Temperatur des Elektronikmoduls, maximal, minimal, durchschnittlich, Emissionseinstellung, Reflektionsenergie-Kompensationstemperatur

Dateiformat .csv

Konfigurierbare Parameter Probenzeitraum, Anzahl der Proben, angesetzte Startzeit und Datum

Modbusadressbereich 1 bis 247

VERWENDEN DES PYROMINI ALS DATENAUFZEICHNUNGSGERÄT

1. Stecken Sie eine MicroSD-Karte in die Halterung auf der Platine im Deckel des Elektronikmoduls des PyroMini.
2. Legen Sie eine Batterie in die Halterung auf der Platine im Deckel, um Datum und Zeit der Abschaltung des PyroMini zu erhalten.
3. Bringen Sie den Deckel wieder an und verbinden Sie den Sensor mit dem Strom.
4. Drücken Sie , um in das Einstellungs-menü und dann , um in das Datenaufzeichnungs-menü zu gelangen. Dort können Sie die Anzahl der aufzuzeichnenden Proben, die Zeitabstände zwischen den Proben und falls notwendig, den automatischen Start der Datenaufzeichnung einstellen.
5. Um die Datenaufzeichnungseinstellungen zu speichern drücken Sie .
6. Um die Datenaufzeichnung manuell zu starten, drücken Sie  in der Temperatur- oder Listenansicht.
7. Während der Aufzeichnung blinkt das Aufzeichnungssymbol  in der Temperatur- und Listenansicht.
8. Um die Datenaufzeichnung zu beenden, drücken Sie .
9. Wenn Sie Daten auf einen Computer übertragen möchten, entfernen Sie die MicroSD-Karte vom Sensor und setzen Sie die Karte in den SD-Karten-Adapter ein (ausgeliefert mit der microSD-Karte, Zubehörmodell MSD). Setzen Sie dann den Adapter in ein SD-Karten-Lesegerät ein.

Hinweis: MicroSDHC-Karten sind mit dem PyroMini nicht kompatibel

INSTALLATION VON MICROSD-KARTEN UND BATTERIEN

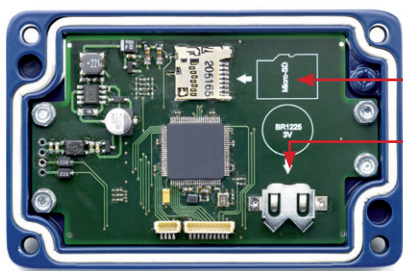

MicroSD-Karte

Batterie
(verwenden Sie 1 x BR
1225 3V)

DATENAUFZEICHNUNGSDATEIEN

Daten werden auf der MicroSD-Karte im Format .csv gespeichert. Dieses Dateiformat kann mit Tabellenkalkulationsprogrammen wie Microsoft Excel geöffnet und importiert werden.

Für jeden Tag, an dem Daten aufgezeichnet werden, wird auf der MicroSD-Karte ein neuer Ordner erstellt.

Jedes mal wenn die Aufzeichnung startet, wird eine neue Protokolldatei erstellt. Als Dateiname wird die Startzeit verwendet.

ABMESSUNGEN

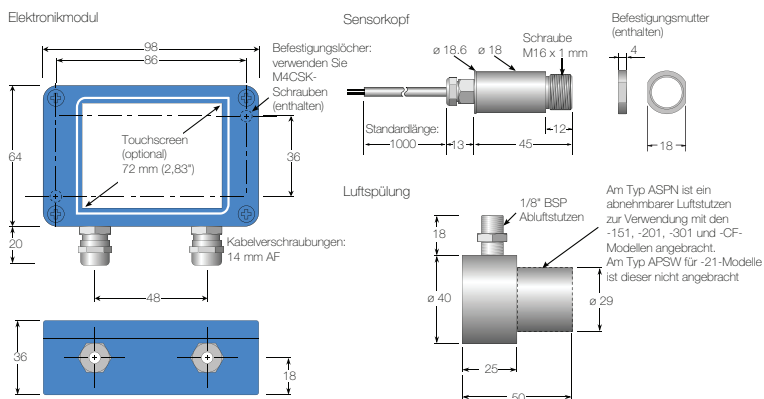

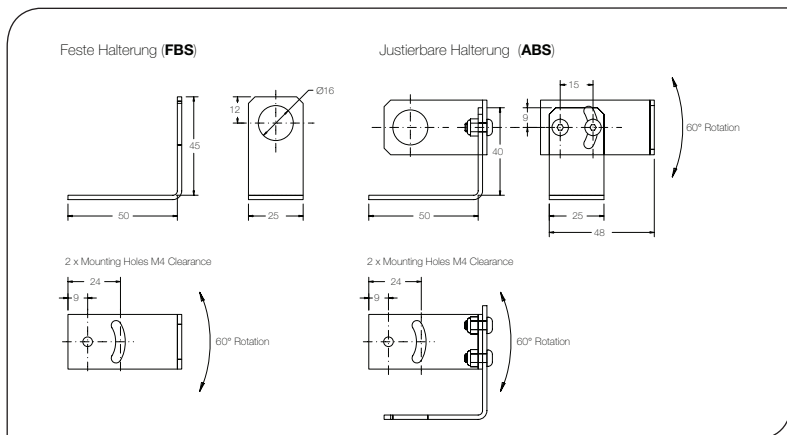

ZUBEHÖR

Für verschiedene Anwendungen und industrielle Umgebungen ist eine Auswahl von anderem Zubehör verfügbar. Dieses kann jederzeit bestellt und vor Ort angebracht werden.

Das folgende Zubehör ist verfügbar:

Feste Halterung (Abmessungen siehe oben): Erlaubt die Justierung durch eindimensionale Drehung. Modellnummer: FBS.

Justierbare Halterung (Abmessungen siehe oben): Erlaubt die Justierung durch zweidimensionale Drehung. Modellnummer: ABS.

Luftpülung (Abmessungen siehe oben): Die unten abgebildete Luftpülmanschette hält Staub, Dämpfe, Feuchtigkeit und andere Verunreinigungen von der Linse fern. Die Manschette muss vollständig eingeschraubt werden. Luft strömt in das 1/8-Zoll-Bsp-Verbindungsstück und aus der vorderen Öffnung. Der Luftstrom sollte nicht mehr als 5 bis 15 Liter/Min betragen. Das Modell APSW eignet sich für die Verwendung mit Sensoren mit 2:1 Optiken. Das Modell APSN eignet sich für alle anderen PyroMini-Modelle.

Laserzieleinrichtung: Wenn die Laserzieleinrichtung während der Installation oder während der Neu-Justage am Sensor angebracht wird, zeigt sie auf die Mitte der vermessenen Stelle. Modellnummer: LSTS.

MicroSD-Karte: Speichert aufgezeichnete Daten. Zur Verwendung mit -BRT und -CRT Modellen. Beinhaltet einen SD-Karten-Adapter. Modellnummer: MSD.

OPTIONEN

Die folgenden Optionen sind verfügbar. Die Optionen sind vorinstalliert und müssen mit dem Sensor bestellt werden.

Kalibrations-Zertifikat: Nachverfolgbares UKAS-Zertifikat, das die gemessenen Temperaturwerte an drei Punkten des Sensor-Temperaturbereichs anzeigt. Modellnummer: CALCERTA.

Erweiterungskabel (30 m maximale Gesamtkabellänge): 1 m Kabel wird mit jedem Sensor als Standard ausgeliefert. Extrakabel kann in Schritten von 1 m hinzugefügt werden. Modellnummer: PMCE (-MA Modellen), PMCEHT (-HA Modellen)

INSTALLATION

Der Installationsprozess besteht aus den folgenden Phasen:

Vorbereitung

Mechanische Installation

Elektrische Installation

Bitte lesen Sie sich die folgenden Abschnitte sorgfältig durch, bevor Sie mit der Installation beginnen.

VORBEREITUNG

Achten Sie darauf, dass der Sensor nach dem Aufstellen nur auf das Ziel weist.

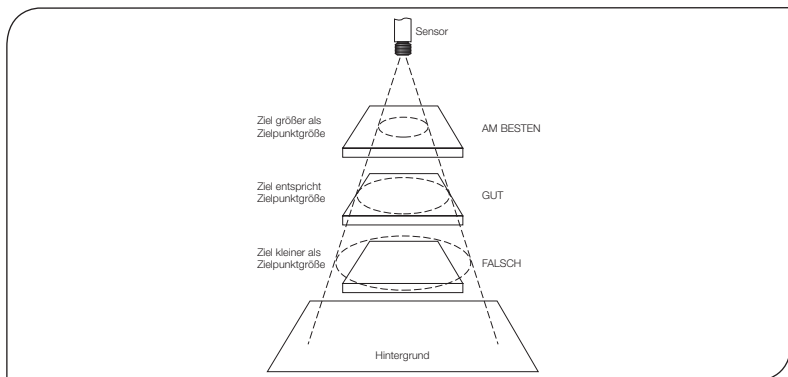

ENTFERNUNG UND ZIELPUNKTGRÖSSE

Die Größe des Messbereichs (Zielpunktgröße) bestimmt die Entfernung zwischen Sensor und Ziel. Die Zielpunktgröße darf die Zielgröße nicht übersteigen. Der Sensor sollte so aufgestellt werden, dass die gemessene Zielpunktgröße kleiner ist als das Ziel.

UMGEBUNGSTEMPERATUR

Der PyroMini ist mit einer Auswahl von zwei Miniatur-Sensorköpfen für die Verwendung in niedrigen und hohen Umgebungstemperaturen verfügbar:

-MA Modelle: Der Sensorkopf ist für den Betrieb in Umgebungstemperaturen von 0°C bis 60°C konstruiert.

-HA Modelle: Der Sensorkopf ist für den Betrieb in Umgebungstemperaturen von 0°C bis 180°C konstruiert. Eine Kühlung ist nicht nötig. Dies spart die Energie und Kosten der Luft- oder Wasserversorgung, um den Sensor zu kühlen.

Vermeiden Sie Wärmeschocks. Warten Sie 20 Minuten, damit sich das Gerät an starke Veränderungen in der Umgebungstemperatur gewöhnen kann.

LUFTQUALITÄT

Rauch, Dämpfe oder Staub können die Linse verunreinigen und zu Fehlern bei der Temperaturmessung führen. In derartigen Umgebungen sollte die Luftspülmanschette verwendet werden, damit die Linse sauber bleibt.

INTERFERENZEN DURCH BEWEGUNG

Das rauscharme Sensorkopfkabel an -HA-Modellen ist gegenüber durch Bewegung verursachten Interferenzen unempfindlich.

Der Sensorkopf kann auf beweglichen Maschinenteilen wie z. B. Roboterarmen angebracht werden, ohne dass die gemessenen Temperaturwerte beeinträchtigt werden.

ELEKTRISCHE INTERFERENZEN

Der PyroMini ist entsprechend industrieller Standards für elektromagnetische Kompatibilität (electromagnetic compatibility - EMC) getestet, wie in den Spezifikationen am Anfang dieser Anleitung angegeben.

Um elektromagnetische Störungen oder "Lärm" auf ein Minimum zu reduzieren, sollte der Sensor entfernt von Motoren, Generatoren und ähnlichen Geräten aufgestellt werden.

NETZSPANNUNG

Achten Sie darauf, dass Sie 24 V Gleichstrom (100 mA) verwenden..

MECHANISCHE INSTALLATION

Alle Sensoren werden mit einem 1m langem Kabel und einer Befestigungsmutter geliefert. Längere Kabel können bestellt werden. Der Sensor kann an Halterungen oder mit Ihrer eigenen Konstruktion befestigt werden. Oder verwenden Sie die festen und verstellbaren Zubehörteile für die Halterung.

Hinweis: Der Sensor darf nur an einem Punkt geerdet sein, nämlich entweder an der Kabelabschirmung oder am Sensorgehäuse. Stellen Sie um Erdschleifen zu vermeiden sicher, dass der Sensor nur an einem dieser Punkte geerdet ist.

ELEKTRISCHE INSTALLATION

ANSCHLÜSSE

-CB and -CRT models

Farbkodes der Sensorkopfkabel
(alle Modelle):
TP+ Blau mit weißem Streifen
TP- Weiß mit blauem Streifen
TH+ Blau
GND (Massekabel) Weiß

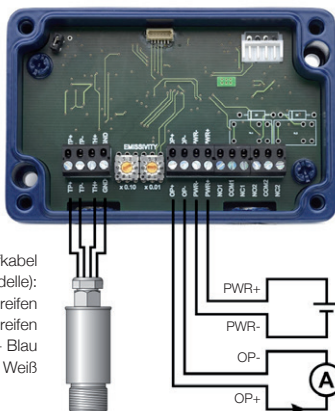

-BB and -BRT models

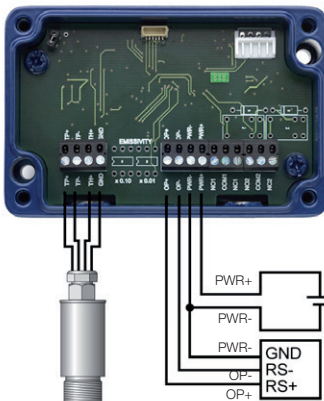

VERDRAHTUNG (ALLE MODELLE)

Überprüfen Sie den Abstand zwischen dem Sensorkopf und dem Elektronikmodul und zwischen dem Elektronikmodul und der Gerätausstattung. Der Sensor kann falls nötig mit einem längeren Kabel zwischen dem Sensorkopf und dem Elektronikmodul bestellt werden.

Das Ausgangskabel des Elektronikmoduls sollte einen äußeren Durchmesser zwischen 3,0 und 6,5 mm haben, mit Leitern der Größe 28 bis 18 AWG.

Die Klemmleisten im Elektronikmodul können, um die Verkabelung zu erleichtern, von der Platine entfernt werden.

Trennen Sie die Platine des Touchscreens nicht von der Hauptplatine, solange der Sensor eingeschaltet ist.

VERKABELUNG (-BB UND -BRT MODELLE)

Wenn Sie mehrere Sensoren in einem einzelnen Modbus-Netzwerk verbinden, sollten alle Sensoren mit einer Verteilerdose an ein einzelnes Netzwerk-Bus-Kabel vom äußersten Sensor bis zum Modbus-Master verbunden werden.

Bis zu 247 Sensoren können in einem einzelnen Modbus-Netzwerk verbunden werden. Jeder Sensor muss eine eindeutige Modbus-Adresse haben. PyroMini-Sensoren werden normalerweise mit der Modbus-Adresse 1 ausgeliefert. Die Modbus-Adresse kann über die Touchscreen-Oberfläche der BRT-Modelle oder über Modbus geändert werden.

Stellen Sie um Datenreflexionen zu vermeiden sicher, dass das Kabel zwischen jedem Sensor und dem Haupt-Netzwerk-Bus so kurz wie möglich ist. Der Netzwerk-Bus sollte zwischen den RS+ und RS- Kabeln mit einem Widerstand von 120 Ohm abgeschlossen werden. Das PWR-Kabel des Bus sollte mit der Signalmasse des Modbus-Master verbunden werden.

MODBUS AUF SERIELLE LEITUNG (RS485)

Interface

Baudrate	9600
Format	8 Datenbits, kein Paritätsbit, 1 Stoppbit
Verzögerung der Antwort (ms)	20

Unterstützte Funktionen

Lesen Sie registrieren	0x03, 0x04
Schreiben Sie ein einzelnes Register	0x06
Schreiben mehrerer Register	0x10
Mask schreiben registrieren	0x16
Lesen / Schreiben	0x17

Diese Liste beinhaltet alle verfügbaren Adressen:

R = read = lesen

W = write = schreiben (einfach, mehrfach oder lesen/schreiben)

MW = Mask write = Mask lesen

Adresse	Länge (Worte)	Beschreibung	R/W/MW
0x00	1	MODBUS Slave-Adresse	R/W*
0x02	2	Registrieren Identifizierung der Sensor Bits 0..19 – Seriennummer Bits 20..23 – Sensor-Typ (12 = PyroMini) Bits 24..26 – Optik Für MA : 0 = 2:1, 1 = 15:1, 2 = 30:1 Für HA : 0 = 20:1 Bits 27..32 – Reserviert	R

Adresse	Länge (Worte)	Beschreibung	R/W/MW
0x06	1	ungefilterte Objekttemperatur	R
0x08	1	Sensor Temperatur	R
0x0A	1	max. Temperatur Halteperiode	R
0x0C	1	min. Temperatur Halteperiode	R
0x0E	1	durchschnittl. Temperatur Halteperiode	R
0x10	1	gefilterte Objekttemperatur	R
0x12	1	PCB-Temperatur	R
0x14	1	Emissionsgrad (1 LSB = 0.0001) Minimum 0.2000, Maximum 1.0000	R/W
0x16	1	reflektierte Temperatur	R/W
0x18	1	Sensor-Status Bits 0..1 – Reserviert Bit 2 – Haltemodus ein (1)/aus (0) Bit 3 - Haltemodus Spitze (1)/Tal (0) Bits 4..6 – Reserviert Bit 7 - Kompensation der reflektierten Energie ein (1)/aus (0) Bits 8..15 – Reserviert	R/W/MW
0x1A	1	Zeit zur Mittelwertberechnung (1 LSB = 0.05 Sek.) Minimum 0.05 Sek., Maximum 60.00 Sek.	R/W
0x1C	1	Zeitraum von halten (1 LSB = 0.05 Sek.) Minimum 0.05 Sek., Maximum 1200.00 Sek.	R/W
0x1E	1	Temperatur bei 4 mA Minimum -20°C, Maximum 900°C	R/W
0x20	1	Temperatur bei 20 mA Minimum 80°C, Maximum 1000°C	R/W
0x22	1	Eingestellter Auslösepunkt Alarm 1 Minimum -20°C, Maximum 1000°C	R/W
0x24	1	Hysterese Alarm 1 Minimum 0°C, Maximum 1000°C Statusverzeichnis Alarm 1 Bit 0 – Relais ausgelöst(R) Bit 1 – Sichtbarer Alarm aktiv (R) Bit 2 – Alarm ausgelöst (R) Bit 3 – Auto Rücksetzung (1)/manuelle Rücksetzung (0) (R/W/MW) Bit 4 – Alarm Quittierung (R/W/MW) Bit 5 – Alarm Rücksetzung (R/W/MW) Bits 6..7 – Vorbehalten Bit 8 – Obergrenzenalarm (1)/ Untergrenzenalarm(0) (R/W/MW) Bit 9 – Alarm aktiviert (1)/deaktiviert (0)	R/W
0x26	1	Bits 10..15 – Vorbehalten	R/W/MW

Adresse	Länge (Worte)	Beschreibung	R/W/MW
0x28	1	Statusverzeichnis Alarm 2 Bit 0 – Relais ausgelöst(R) Bit 1 – Sichtbarer Alarm aktiv (R) Bit 2 – Alarm ausgelöst (R) Bit 3 – Auto Rücksetzung (1)/manuelle Rücksetzung (0) (R/W/MW) Bit 4 – Alarm Quittierung (R/W/MW) Bit 5 – Alarm Rücksetzung (R/W/MW) Bit 6 – Vorbehalten Bit 7 – Temperatur des gefilterten Objekts (1)/Kopftemperatur (0) (R/W/MW) Bit 8 – Obergrenzenalarm (1)/Untergrenzenalarm(0) (R/W/MW) Bit 9 – Alarm aktiviert (1)/deaktiviert (0) Bits 10..15 – Vorbehalten	R/W/MW
0x2A	1	Eingestellter Auslösepunkt Alarm 2 Minimum -20°C, Maximum 1000°C	R/W
0x2C	1	Hysterese Alarm 2 Minimum 0°C, Maximum 1000°C	R/W

* Das Einzelregister schreibt nur. Eine neue Adresse ist erst nach erneutem Einschalten wirksam.

Bemerkungen:

Alle Temperaturen in Zehntelgrad

Verändern von bereits geschriebenen und gespeicherten Bits oder in nicht gelisteten Speichern können Fehlfunktionen auslösen

Alle Schreib- und Ausblendefunktionen werden in einem nichtflüchtigen Speicher gesichert

Weitere Informationen erhalten Sie unter <http://www.modbus.org/specs.php>

Verwenden Sie die Adresse 255 um mit jedem verbundenen Sensor zu kommunizieren (nur ein Sensor angeschlossen)

Verwenden Sie die Adresse 0 um mit allen verbundenen Sensoren zu kommunizieren (es wird keine Antwort erwartet)

BETRIEB

Wenn der Sensor aufgestellt ist und die entsprechenden Strom-, Luft-, Wasser- und Kabelanschlüsse gesichert sind, kann das System mit den folgenden einfachen Schritten auf Dauerbetrieb eingestellt werden:

1. Schalten Sie die Stromversorgung des Sensors ein
2. Schalten Sie die verbundenen Instrumente ein
3. Lesen, kontrollieren oder zeichnen Sie die Temperatur auf

WICHTIG

Achten Sie beim Einsatz des Sensors auf die folgenden Punkte:

- Wenn der Sensor erheblichen Temperaturschwankungen ausgesetzt wird (heiss/kalt oder kalt/heiss), sind 20 Minuten notwendig, damit sich die Temperatur vor der Temperaturmessung und -aufzeichnung stabilisieren kann.
- Betreiben Sie den Sensor nicht in der Nähe großer elektromagnetischer Felder (z.B. von Lichtbogenschweißgeräten oder Induktionsheizgeräten). Elektromagnetische Störungen können zu Messfehlern führen.
- Die Kabel dürfen nur mit den korrekten Anschlüssen verbunden werden.

MESSUNG DURCH EINE SCHEIBE

Der Pyro Mini kann die Temperatur eines Ziels durch eine Scheibe aus für Infrarotstrahlung von 8-14 Mikron durchlässigem Material messen. Die Emissionseinstellung des Sensors sollte angepasst werden, um die vorhandene Scheibe auszugleichen. Für mehr Informationen zur Verwendung des PyroMini mit einer Scheibe kontaktieren Sie bitte Calex.

WARTUNG

Unsere Kundendienstmitarbeiter können bei Anwendungen, Kalibrierung, Reparaturen und Lösung konkreter Probleme helfen. Setzen Sie sich bitte mit unserer Kundendienstabteilung in Verbindung, bevor Sie Geräte zurücksenden. Häufig können Probleme telefonisch gelöst werden. Wenn der Sensor nicht ordnungsgemäß funktioniert, versuchen Sie, das unten aufgeführte Symptom dem entsprechenden Problem zuzuordnen. Wenn die Tabelle nicht weiterhilft, kann Ihnen Calex möglicherweise telefonisch weitere Tipps geben.

Störungssuche		
Symptom	Wahrscheinliche Ursache	Lösung
Kein Ausgangssigna	Keine Stromzufuhr am Sensor	Stromanschluss überprüfen
Falsche Temperatur	Falscher Kabelanschluss	Kabelfarbcode überprüfen
Falsche Temperatur	Fehlerhaftes Sensorkabel	Kabelkontinuität überprüfen
Falsche Temperatur	Blickfeld blockiert	Blockierung entfernen

REINIGEN DER LINSE

Halten Sie die Linse stets sauber. Fremdkörper auf der Linse würden die Messgenauigkeit beeinträchtigen. Blasen Sie lose Partikel mit einem Gebläse von der Linse (sofern Sie nicht die Luftspülmanschette verwenden).

GARANTIE

Calex gewährleistet, dass jedes von Calex hergestellte Instrument über einen Zeitraum von zwei Jahren ab Kaufdatum bei normalem Gebrauch und ordnungsgemäßer Wartung frei von Material- und Verarbeitungsfehlern ist. Diese Garantie gilt nur für den ursprünglichen Käufer und richtet sich nach den Calex-Geschäftsbedingungen.

La serie PyroMini es una gama de sensores de temperatura en miniatura sin contacto por infrarrojos la electrónica separada.

Todos los modelos tienen un ajuste de la emisividad y son capaces de medir en una gran variedad de materiales, incluyendo alimentos, papel, textiles, plásticos, cuero, tabaco, productos farmacéuticos, productos químicos, caucho, carbón y asfalto.

La interfaz de pantalla táctil opcional proporciona la indicación de temperatura, alarmas, configuración del sensor y registro de datos en la tarjeta MicroSD. El cabezal opcional para alta temperatura puede usarse en temperaturas de hasta 180 ° C sin refrigeración. En los modelos de alta temperatura, el cable de bajo nivel de ruido es resistente a la interferencia del movimiento, por lo que es ideal para su montaje donde se mueven objetos como brazos robot.

Están disponibles varios tipos de ópticas para medir superficies pequeñas o grandes en distancias cortas o largas, y hay una variedad de salidas 4-20 mA, RS485 Modbus y relés de alarma.

ESPECIFICACIÓN GENERAL

Rango de temperatura	Ver la tabla de números de modelo
Span temperatura máxima (-modelos CRT)	1020°C
Span de temperatura mínima (-modelos CRT)	100°C
Salida	4 a 20 mA ó RS485 Modbus
Campo de visualización	Ver la tabla de números de modelo
Precisión	±1% de lectura o ±1°C, la cifra que sea mayor
Repetibilidad	±0,5% de lectura o ±0,5°C, la cifra que sea mayor
Rango de ajuste de emisividad	0.20 a 1.00
Método de ajuste de la emisividad	Modelos CB: mediante dos interruptores rotativos en el módulo electrónico modelos BB - y - BT: vía RS485 modelos CRT - y - BT: mediante pantalla táctil
Tiempo de respuesta	240ms (90% respuesta)
Respuesta espectral	8 a 14µm
Tensión de alimentación	24Vcc ± 5%
Consumo máximo de corriente	100 mA
Impedancia máxima de circuito	900 Ohmios (4-20mA Salida, modelos CB y CRT)
Relés de alarma (-modelos CRT)	2 x relés de alarma conmutados 24 V DC, 1 A, 500 V DC

MECÁNICA

	Cabeza medidora	Módulo electrónico
Construcción	Acero inoxidable 316	Aluminio fundido
Dimensiones principales	Ø18 x 45 mm	98(w) x 64(h) x 36(d) mm
Montaje	Tornillos con rosca M16 x 1 mm	Dos tuercas M4 para montaje en pared (ver diagrama)

Longitud del cable (del sensor al módulo electrónico) 1 m (estándar), hasta 30 m (opcional)

Peso con 1 m Cable 390 g (aprox.)

Conexiones del cable Ciemas desmontables con tornillos (ver conexiones). Tamaño del conductor: 28 AWG a 18 AWG

Prensaestopas Adecuado para diámetros de cable 3.0 a 6.5 mm

AMBIENTAL

	Sensor	Módulo electrónico (sin pantalla táctil)	Módulo electrónico (con pantalla táctil)
Protección Ambiental	IP65 (NEMA 4)	IP65 (NEMA 4)	-
Temperatura ambiente	consulte la tabla de números de modelo	0°C a 60°C	0°C a 60°C
Humedad relativa	Máxima 95% sin condensación	Máxima 95% sin condensación	Máxima 95% sin condensación
Marcado CE	sí	sí	sí
Cumple RoHS	sí	sí	sí

NORMAS DE COMPATIBILIDAD ELECTROMAGNÉTICA:

Clase	estándar	Descripción
Directiva EMC	EN61326-1:2006	Equipos eléctricos de medida, control y uso en laboratorio o Industrial
- Inmunidad	IEC 61000-4-2	Inmunidad de descarga electrostática
	IEC 61000-4-3	Inmunidad de campo electromagnético
	IEC 61000-4-4	Inmunidad de ráfaga
	IEC 61000-4-5	Inmunidad de oleada
	IEC 61000-4-6	inmunidad a la radiofrecuencia
- Emisiones	EN 55022A	RF Emisiones Clase A
	EN 55022B	RF Emisiones Clase B

NÚMEROS DE MODELO

Las siguientes combinaciones de temperatura ambiente, óptica, rango de medida de temperatura, salida e interfaz están disponibles en los sensores PyroMini:

Serie	Cabeza medidora rango de temperatura	Campo de visión	Rango de temperatura de medición	Salida e interfaz
PM	MA	21 151 301 CF	LT MT HT XT	CB
			CT	CRT BB BRT
	HA	201	HT XT	CB
			CT	CRT BB BRT

GAMA DE TEMPERATURAS DE FUNCIONAMIENTO DEL SENSOR

- MA 0°C a 60°C
- HA 0°C a 180°C

Los sensores para alta temperatura ambiente modelos -HA son capaces de soportar temperaturas de hasta 180 °C sin refrigeración. Están disponibles con óptica de 20:1.

No es necesario suministrar enfriamiento por aire o agua por lo que el sensor en miniatura es mucho más pequeño que los voluminosos sensores refrigerados.

CAMPO DE VISIÓN

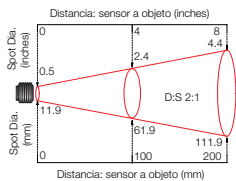

-21

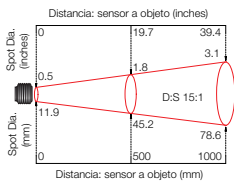

-151

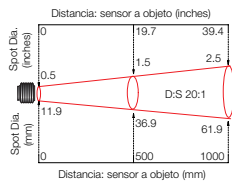

-201

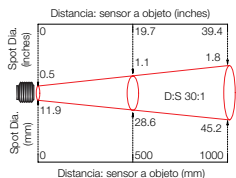

-301

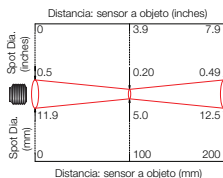

-CF

Diámetro de objetivo punto medido frente a la distancia de detección cabeza al 90% de la energía

RANGO DE TEMPERATURA DE MEDICIÓN

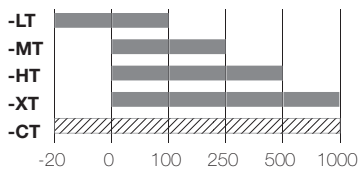

■ Fijo (p.e. -MT: 0 °C 4 mA, 250 °C 20 mA)

▨ Modelos -CRT: configurable dentro de esta gama de la salida de 4 a 20 mA
Modelos -BRT y -BB: rango completo de temperatura en la salida digital

SALIDA E INTERFAZ

- CB salida 4 a 20 mA, sin pantalla táctil
- CRT salida 4 a 20 mA y dos salidas de relé para alarma, con pantalla táctil
- BB salida RS485 Modbus, sin pantalla táctil
- BRT salida RS485 Modbus y dos salidas de relé para alarma, con pantalla táctil

EJEMPLO - PM-MA-301-CT-CRT

Serie	Cabeza medidora rango de temperatura	Campo de visión	Rango de temperatura de medición	Salida e interfaz
PM PyroMini	-MA 0°C a 60°C	-301 30:1	-CT configurable -20 a 1000°C	-BRT salida RS485 Modbus y dos salidas de relé para alarma, con pantalla táctil

AJUSTE DE EMISIVIDAD (MODELOS-CB)

El ajuste de emisividad en los modelos PyroMini -CB puede ajustarse mediante dos interruptores rotatorios dentro de la caja electrónica. Para ajustar la emisividad:

Coloque el interruptor de la izquierda en el primer dígito después del punto decimal (0.1).
Coloque el interruptor de la derecha en el segundo dígito después del punto decimal (0.01).

Para introducir un ajuste de emisividad de 1.00, colocar ambos interruptores en 0.

El ajuste de emisividad mínimo es 0.2. Si se selecciona una emisividad menor, el sensor, por defecto, pondrá el ajuste de emisividad de 0,95.

Por ejemplo:

Interruptor izquierdo	Interruptor derecho	ajuste de emisividad
6	3	0.63
0	0	1.00

PANTALLA TÁCTIL (MODELOS -CRT Y - BRT)

La interfaz opcional de pantalla táctil retro-iluminada montada en la tapa del módulo electrónico ofrece una indicación grande y brillante de la temperatura medida, así como opciones para la configuración completa del sensor. La vista en forma de gráfico muestra el historial de la temperatura medida.



En condiciones de alarma, la pantalla cambia de color para proporcionar una indicación de alarma inmediata y evidente. Los Niveles y los modos de alarma se pueden configurar mediante la pantalla táctil.

ESPECIFICACIONES DE LA PANTALLA TÁCTIL













Formato de visualización de pantalla táctil 2.83 "(72 mm) tacto resistivo de TFT, 320 x 240 píxeles, retro-iluminación

Parámetros configurables	Rango de temperatura, unidades de temperatura, ajuste de emisividad, compensación de la energía reflejada, alarmas, procesamiento de señales, dirección Modbus (modelos BRT), fecha y hora, registro de datos
Unidades de Temperatura	° C o ° F configurable
Resolución de la Temperatura	0.1 °
Configuración Alarma	Dos alarmas con nivel ajustable, configurable individualmente como ALTA o BAJA. La alarma 2 puede ajustarse a la temperatura deseada o a la temperatura interna del sensor
Procesamiento de la señal	Señal media, pico alto, pico bajo valle espera, mínimo, máximo



INTERFAZ DE USUARIO

Vista por defecto	Temperatura
<p>Ajuste unidades temperatura</p> <p>Para seleccionar la temperatura indicada</p>  	<p>Presione “° C” para cambiar a ° F y viceversa. Las unidades se cambian a lo largo de toda la interfaz.</p> <p>Filtered temp - Temperatura filtrada Average temp - Temperatura media Unfiltered temp - Temperatura sin filtrar</p> <p>Tarjeta MicroSD insertada</p> <p>Registro de datos programado habilitado</p>

	Lista de temperaturas (List View)
Filtered temp	Temperatura filtrada
Unfiltered temp	Temperatura sin filtrar
Average temp	Temperatura media
Maximum Temp	Temperatura máximo
Minimum Temp	Temperatura mínimo
Sensor Temp	Temperatura del sensor
Reflected Temp	Temperatura reflejada

 	<p>Bloquear y desbloquear (Lock/Unlock)</p> <p>La contraseña por defecto es 1234.</p>
	<p>Cambiar contraseña</p>
 	<p>Iniciar sesión</p> <p>Detener sesión</p>
	<p>Gráfico de temperatura (Graph)</p>
 	<p>Reiniciar el gráfico</p> <p>Vista con desplazamiento en tiempo real</p>
	<p>Reconocer alarmas</p>
	<p>Configuración (Settings)</p> <p>Pulse  aplicar para guardar la configuración o salir  para salir de la pantalla sin guardar los cambios.</p>



SETTINGS

	Fecha hora (Date and Time)
	Procesamiento de salida (Output Processing)
Averaging Period Hold Mode Hold Period	Período para hacer la media Modo de visualización del pico o el Valle apagado Hold PeriodPeríodo de mantenimiento
	Registro de datos (Data Logging)
Sample Period Number of Samples Enable Scheduled Start Date and Time	Período de la muestra Número de muestras Habilitar inicio programado Fecha y hora

	<p>Emisividad y compensación (Emissivity and Compensation)</p>
<p>Emissivity Setting</p> <p>Enable Reflected Energy Compensation</p> <p>Reflected Temperature</p>	<p>Ajuste de emisividad</p> <p>Permitir la compensación de la energía reflejada</p> <p>Temperatura reflejada</p>

	<p>4 a 20 mA de salida (modelos -CRT) (4-20 mA output)</p>
<p>Temperature at 4 mA</p> <p>Temperature at 20 mA</p>	<p>Temperatura a 4 mA</p> <p>Temperatura a 20 mA</p>

	<p>Dirección Modbus (modelos -BRT)</p>
--	---

	<p>Alarmas (Alarms)</p>
	<p>Alarmas sin enclavamiento</p>

SETTINGS > ALARMS

	Alarma 1 y alarma 2
Alarm Set Point	Punto de ajuste de alarma
Hysteresis	Histéresis
Filtered Temperature / Sensor Temperature	Temperatura Filtrada o temperatura del Sensor (sólo alarma 2)
Alarm Type	Tipo Alarma: High - alto Low - bajo Off - apagado
Reset	Reinicio Automatic - automático Manual - Manual

	Registro de la alarma (Alarm Logging)
Log Trigger Time	Tiempo de activación de registro
Log Data While Triggered	Datos de registro mientras dispara
Log Acknowledge Time	reconocer tiempo de Registro
Log Reset Time	Reset Tiempo de registro

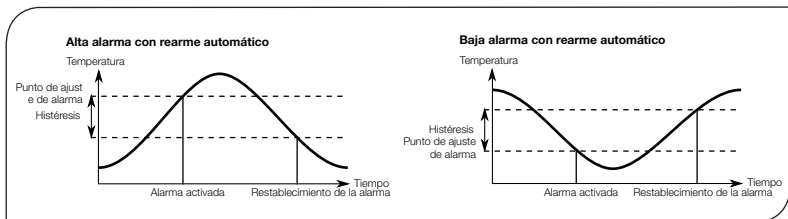
OPERACIÓN DE ALARMA CON REARME AUTOMÁTICO E HISTÉRESIS

REGISTRO DE DATOS (MODELOS -CRT Y - BRT)

El PyroMini puede utilizarse como un registrador de datos independiente.

Los modelos PyroMini -CRT y - BRT incluyen una slot para tarjetas MicroSD para registro de datos, que puede configurarse mediante la Interfaz de la pantalla táctil. El usuario puede seleccionar la frecuencia de muestreo y el número de muestras a tomar y programar que el registro de datos empiece en un momento determinado.

Con una tarjeta de 2 GB, el usuario puede almacenar 28,4 millones de lecturas, que proporcionan casi de 1 año de información a la velocidad más rápida posible de 1 muestra de 1al segundo.

Los datos se almacenan en la tarjeta MicroSD en formato .csv y pueden verse y editarse fácilmente utilizando software de hoja de cálculo.







Está disponible como accesorio opcional Un adaptador de tarjeta MicroSD a tarjeta SD.

La ranura del slot de la tarjeta MicroSD y la batería se encuentran en la placa de circuito de pantalla táctil en la tapa del PyroMini. Las lecturas incluye la hora y la fecha basadas en el reloj interno del sensor. El reloj se resetea cuando se desconecta la alimentación, o continuará si el equipo está equipado con la batería

ESPECIFICACIONES DEL REGISTRO DE DATOS

Intervalo de registro de datos	de 1 a 86.400 segundos (1 día)
Máxima capacidad de la tarjeta MicroSD.	2 GB (no incluida)
Batería de reloj interna	1 x 3V BR 1225 (no incluida)
Variables registradas	Temperatura, temperatura del sensor, temperatura del módulo electrónico, max, min, promedio, ajuste emisividad, temperatura de compensación de la energía reflejada
Archivo en formato	.csv
Parámetros configurables	Período de muestreo, número de muestras, fecha y hora de inicio
Dirección Modbus	del 1 a 247

USANDO EL PYROMINI COMO UN REGISTRADOR DE DATOS

1. Inserte una tarjeta MicroSD en el soporte de la tarjeta de circuitos dentro de la tapa del módulo de la electrónica del PyroMini.
2. Para mantener la fecha y hora cuando se apague el PyroMini, montar una batería en el circuito dentro de la tapa.
3. Vuelva a colocar la tapa y conecte la fuente de alimentación al sensor.
4. Para establecer el número de muestras que se registren, el período de tiempo entre muestras y, si es necesario, para programar el inicio del registro de datos automático, pulse  para acceder al menú de configuración, luego presione  para acceder a las opciones de registro de datos.
5. Para guardar la configuración de registro de datos, pulse .
6. Para iniciar manualmente el registro de datos, pulse  sobre la vista de temperatura o la de lista.
7. Mientras que el registro está en curso, el icono de registro  parpadea en la vista de la temperatura y la vista de lista.
8. Para detener el registro de datos, pulse .
9. Para transferir datos a un ordenador, quitar la tarjeta MicroSD del sensor, inserte la tarjeta en el adaptador de tarjeta SD (suministrado con la tarjeta MicroSD, accesorio modelo MSD) e inserte el adaptador en un lector de tarjetas SD.

Nota: Las tarjetas MicroSDHC no son compatibles con el PyroMini.

INSTALACIÓN DE LA TARJETA MICROSD Y BATERÍA

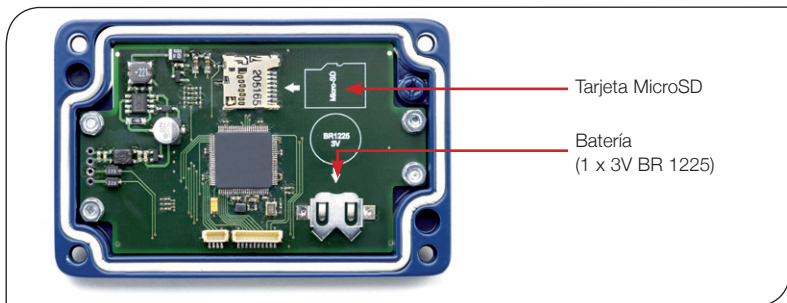

ARCHIVOS DE REGISTRO DE DATOS

Los datos se guardan en la tarjeta MicroSD en formato CSV. Este formato de archivo puede ser abierto o importado por software de hoja de cálculo como Microsoft Excel.

Se creará una nueva carpeta en la tarjeta MicroSD cada día que los datos se registran.

Se crea un nuevo archivo de registro cada vez que se inicia el registro. La hora de salida se utiliza como nombre de archivo.

DIMENSIONES

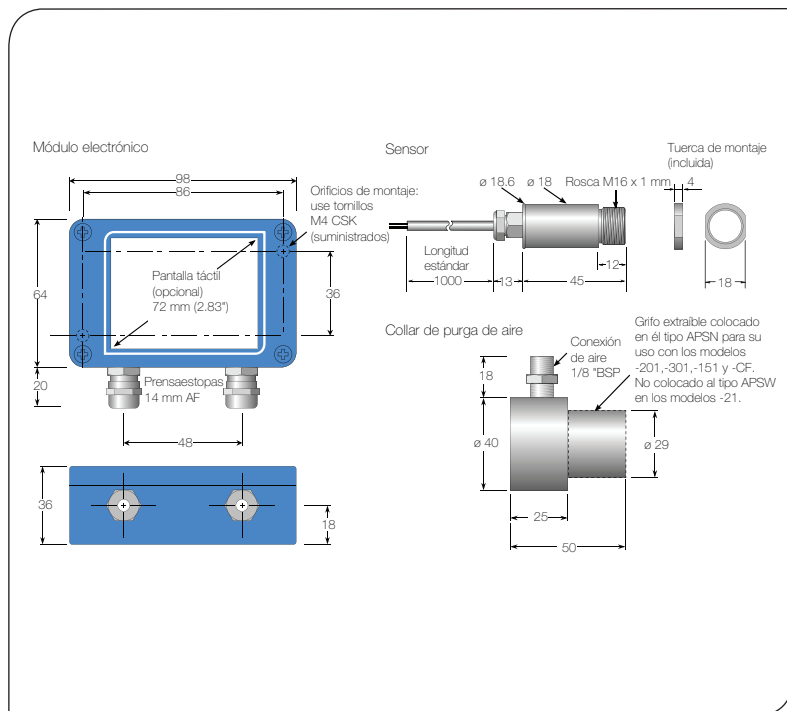

Soporte de montaje fijo (FBS)

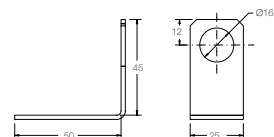

2 x orificios de montaje M4

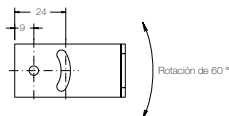

Soporte de montaje ajustable (ABS)

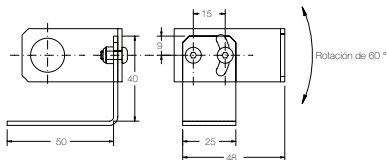

2 x orificios de montaje M4

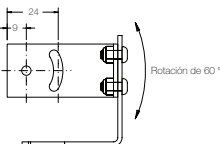

ACCESORIOS

Hay disponible una gama de accesorios para adaptarse a diferentes aplicaciones y entornos industriales. Estos se puede pedir en cualquier momento y pueden montarse por el usuario. Los siguientes accesorios están disponibles:

Soporte de montaje fijo (dimensiones ver arriba): permite el ajuste rotacional en una dimensión. Número de modelo: FBS.

Soporte de montaje ajustable (ver arriba para dimensiones): permite el ajuste rotacional en dos dimensiones. Número de modelo: ABS.

Collar para purga de aire (dimensiones ver arriba): modelo APSW es para uso con sensores con óptica de 2:1. El modelo APSN es para uso con todos los otros modelos de PyroMini.

Herramienta de apunte por láser: Se coloca en el sensor durante la instalación o reajuste de este, La herramienta de apuntado por láser señala el centro del punto medido. Número de modelo: LSTS.

Tarjeta microSD: Almacena los datos que se registran. Para uso con modelos - BRT y -CRT. Incluye adaptador de tarjeta SD. Número de modelo: MSD

OPCIONES

Las siguientes opciones están disponibles. Las opciones son instaladas en la fábrica y deben pedirse con él sensor.

Calibración Certificado: Certificado trazable UKAS mostrando la temperatura medida en tres puntos en toda la gama de temperaturas del sensor. Número de modelo: CALCERTA.

Cable Extendido (longitud cable total máxima de 30 m): con cada sensor se suministra 1 m de cable como estándar. Se puede agregar cable adicional a este en incrementos de 1 m. número de modelo: PMCE (Modelos -MA), PMCEHT (modelos -HA).

INSTALACIÓN

El proceso de instalación consiste en las siguientes etapas:

Preparación

Instalación mecánica

Instalación eléctrica

Leer las siguientes secciones con detenimiento antes de proceder a la instalación.

PREPARACIÓN

Asegurarse de que el sensor se coloca de manera que esté enfocando solamente a la diana.

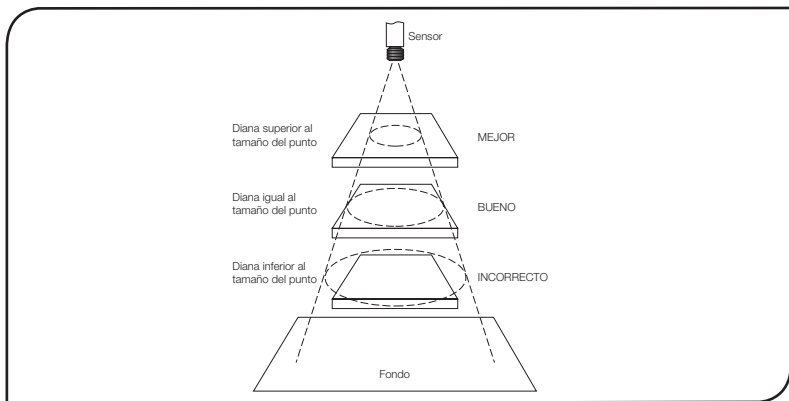

DISTANCIA Y TAMAÑO DE LA ZONA DE MEDICIÓN

El tamaño de la zona de medición a medir determina la distancia entre el sensor y la diana. El tamaño de la zona de medición no debe ser mayor que el de la diana. El sensor debe ser instalado de manera que la zona de medición determinada sea menor que la diana.

TEMPERATURA AMBIENTE

El PyroMini está disponible con dos tipos de sensores de detección en miniatura, para uso con temperatura ambiente baja o alta:

Modelos -MA: la cabeza medidora está diseñada para funcionar en temperaturas de 0 °C a 60 °C.

-Modelos HA: la cabeza medidora está diseñada para funcionar en temperaturas de 0 °C a 180 °C. no se requiere refrigeración, lo que ahorra energía y el costo del suministro de aire o agua a para enfriar el sensor.

CALIDAD ATMOSFÉRICA

Los humos o el polvo pueden contaminar la lente y causar errores en la medición de la temperatura. El aro de purga de aire debe usarse en ambientes de este tipo para ayudar a mantener la lente limpia.

INTERFERENCIA DEL MOVIMIENTO

El cable de bajo nivel de ruido en los modelos - HA es resistente a la interferencia causada por el movimiento.

La cabeza medidora puede montarse en maquinaria en movimiento como brazos robot sin afectar la exactitud de la temperatura medida.

INTERFERENCIA ELÉCTRICA

El PyroMini está probado a los estándares industriales para compatibilidad electromagnética (EMC) como se muestra en las Especificaciones al principio de este manual.

Para reducir al mínimo la interferencia electromagnética o el "ruido", el sensor debe ser instalado alejado de motores, generadores o similares.

SUMINISTRO ELÉCTRICO

Asegurarse de usar un suministro eléctrico de 24Vcc (100mA).

INSTALACIÓN MECÁNICA

Todos los sensores vienen con 1 metro de cable y una tuerca de montaje. Están disponibles bajo pedido Cables más largos. Sensor puede ser instalado en una consola o dispositivos de diseño propio, o puede usar los accesorios de consola fija y regulable de montaje que se muestran debajo.

Nota: El sensor debe ser conectado a la tierra en un único punto, en el blindaje del cable o en la carcasa del sensor. Para evitar bucles por tierra, asegúrese que el sensor está conectado a tierra en sólo uno de estos puntos.

INSTALACIÓN ELÉCTRICA

CONEXIONES

Modelos CB y CRT

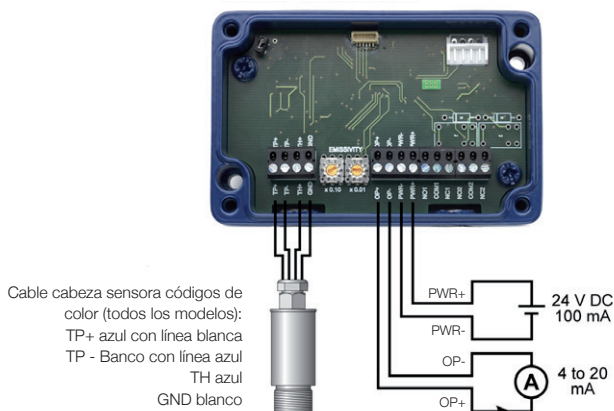

Modelos BB y BRT

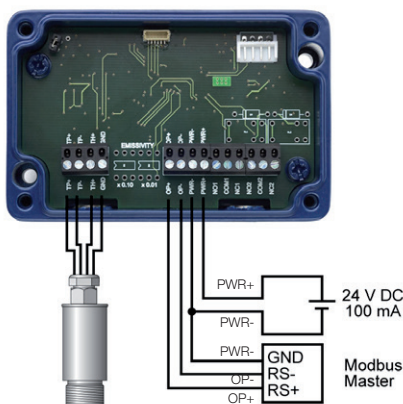

CABLEADO (TODOS LOS MODELOS)

Compruebe la distancia entre la cabeza medidora y el módulo electrónico y entre el módulo electrónico y la instrumentación. Si es necesario, el sensor se puede pedir con un cable más largo entre la cabeza medidora y el módulo electrónico.

El cable de salida del módulo de electrónica debe tener un diámetro exterior entre 3.0 y 6.5 mm, con conductores de tamaño de 28 a 18 AWG.

Los bloques de terminales en el módulo electrónico pueden quitarse de la platina para un más fácil cableado.

No desconecte la placa de circuito de pantalla táctil de la placa de circuito principal mientras el sensor esté encendido.

CABLEADO (MODELOS -BB Y - BRT)

Al conectar varios sensores en una sola red Modbus, todos los sensores deben ser conectados a través de una caja a un solo cable de bus de red, desde el sensor más lejano a la maestro Modbus.

Pueden conectarse Hasta 247 sensores a una red Modbus. Cada sensor debe tener un Dirección única de Modbus. Los sensores PyroMini normalmente se envían con Dirección Modbus 1. La Dirección Modbus puede cambiarse mediante la interfaz de pantalla táctil en modelos - BRT, o a través de Modbus.

Para evitar las reflexiones de datos, asegúrese de que el cable entre cada sensor y el cable principal de la red sea lo más corto posible. El cable de la red debe ser terminado con una resistencia de 120Ω entre los cables RS+ y RS-. El cable PWR- del bus debe conectarse a la señal de tierra del maestro Modbus.

MODBUS A TRAVÉS DE LA LÍNEA SERIE (RS485)

Interfaz

Velocidad de transmisión	9600
Formato	8 bits de datos, sin bit de paridad, 1 bit de parada
Retardo de respuesta (ms)	20

Funciones soportadas

Lea el registro	0x03, 0x04
Escribe único registro	0x06
Escriba registro múltiple	0x10
Máscara escribir registro	0x16
Ler/escribir	0x17

La siguiente lista incluye todas las direcciones disponibles:

R = Lectura

W = Escribir (única, múltiple o Ler/escribir)

MW = Máscara de escritura

Dirección	Longitud (palabras)	Descripción	R/W/MW
0x00	1	Dirección del esclavo Modbus	R/W*
0x02	2	Registro de identificación del sensor Bits 0..19 - número de serie Bits 20..23 - Tipo de sensor (12 = PyroMini) Bits 24..26 - campo de visión Para MA : 0 = 2:1, 1 = 15:1, 2 = 30:1 Para HA : 0 = 20:1 Bits 28..32 - Reservado	R

Dirección	Longitud (palabras)	Descripción	R/W/MW
0x06	1	Temperatura sin filtrar del objeto	R
0x08	1	Temperatura del cabezal sensor	R
0x0A	1	Temperatura máxima durante el periodo de retención	R
0x0C	1	Temperatura mínima durante el periodo de mantenimiento	R
0x0E	1	Temperatura media durante el período de espera	R
0x10	1	Temperatura filtrado del objeto	R
0x12	1	Temperatura de PCB	R
0x14	1	Emisividad (1 LSB = 0.0001) Mínima 0.2000, máximo 1.0000	R/W
0x16	1	Temperatura reflejada	R/W
0x18	1	Registro de estado del sensor Bits 0..1 – Reservados Bit 2 - mantenga procesamiento activada (1) / desactivada (0) Bit 3 - Mantenga picos (1) / valles (0) Bits 4..6 – Reservados Bit 7 – Compensación de la energía reflejada activada (1) / desactivada (0) Bits 8..15 – Reservados	R/W/MW
0x1A	1	Período de promedio (1 LSB = 0.05 segundos) Mínima 0.05 segundos, máximo 60.00 segundos	R/W
0x1C	1	Mínima 0.05 segundos, máximo 1200.00 segundos	R/W
0x1E	1	Temperatura a 20 mA Mínima 80 ° C, máximo 1000 ° C	R/W
0x20	1	Temperatura a 20 mA Mínima 80 ° C, máximo 1000 ° C	R/W
0x22	1	Punto de ajuste de alarma 1 Mínimo -20 ° C, máximo 1000 ° C	R/W
0x24	1	Histéresis de alarma 1 Mínimo 0 ° C, máximo 1000 ° C	R/W
0x26	1	Registro del estado de alarma 1 Bit 0 – relé activado (R) Bit 1 – alarma Visible activa (R) Bit 2 – alarma activada (R) Bit 3 – Auto reset (1) / manual reset (0) (R/W/MW) Bit 4 – reconocer alarma (R/W/MW) Bit 5 – restablecimiento de la alarma (R/W/MW) Bits 6..7 – reservados Bit 8 – alta alarma (1) / alarma baja (0) (R/W/MW) Bit 9 – alarma activada (1) / desactivada (0) Bits 10..15 – reservados	R/W/MW

Dirección	Longitud (palabras)	Descripción	R/W/MW
0x28	1	Registro del estado de alarma 2 Bit 0 – relé activado (R) Bit 1 – alarma Visible activa (R) Bit 2 – alarma activada (R) Bit 3 – Auto reset (1) / reset manual (0) (R/W/MW) Bit 4 – reconocer alarma (R/W/MW) Bit 5 – restablecimiento de la alarma (R/W/MW) Bit 6 – reservada Bit 7 – temperatura filtrada del objeto (1) / Temperatura sensor (0) (R/W/MW) Bit 8 – alta alarma (1) / alarma baja (0) (R/W/MW) Bit 9 – alarma activada (1) / desactivada (0) Bits 10..15 – reservados	R/W/MW
0x2A	1	Punto de ajuste de alarma 2 Mínimo -20 ° C, máximo 1000 ° C	R/W
0x2C	1	Histéresis de alarma 2 Mínimo 0 ° C, máximo 1000 ° C	R/W

* Registro único escribe solo. Nueva dirección no entrará en vigor hasta el siguiente encendido.

Notas:

1. Todas las temperaturas están en décimas de grados C
2. Escribiendo a los bits que figuran como Reservado o registros cotizadas, se podría ocasionar un mal funcionamiento
3. Todas las operaciones de escritura y la máscara se guardan en la memoria no volátil
4. Para más información, por favor consulte <http://www.modbus.org/specs.php>

FUNCIONAMIENTO

Una vez que el sensor está en posición y el suministro eléctrico, el aire, el agua y las conexiones de cables apropiadas están seguras, el sistema está listo para el funcionamiento continuo, una vez se completen los sencillos pasos siguientes:

1. Encienda la alimentación del sensor
2. Encienda la instrumentación conectada
3. Leer, monitorear o registrar la temperatura

IMPORTANTE

Prestar atención a lo siguiente al usar el sensor:

- Si el sensor se expone a cambios significativos de temperatura ambiental (de caliente a frío o de frío a caliente), dejar pasar 20 minutos para que la temperatura se estabilice antes de tomar o registrar temperaturas.
- No hacer funcionar el sensor cerca de grandes campos electromagnéticos (ejemplo, cerca de soldadoras por arco o calentadores por corrientes de inducción). Las interferencias electromagnéticas pueden causar errores de medición.
- Los hilos deben ser conectados solamente a las terminales apropiadas.

VISUALIZACIÓN A TRAVÉS DE UNA VENTANA

El PyroMini es capaz de medir la temperatura de un objetivo a través de una ventana de un material que sea transmisor a la radiación infrarroja en 8-14 micras. El ajuste de emisividad del sensor debe ser ajustado para compensar la presencia de la ventana. Póngase en contacto con Calnex para obtener más información sobre el uso del PyroMini con una ventana.

MANTENIMIENTO

Nuestros representantes de servicio al cliente están a su disposición para asistirles en aplicaciones, calibración, reparación y soluciones a problemas específicos. Contactar nuestro Departamento de servicio antes de devolver el equipo. En muchos casos, los problemas pueden resolverse por teléfono. Si el sensor no funciona como debiera, intentar encontrar el síntoma de entre los siguientes para identificar su problema. Si la tabla no le sirve de ayuda, llamar a Calnex para mayor asistencia.

Identificación de problemas		
Síntoma	Causa probable	Solución
No funciona	No hay suministro eléctrico al sensor	Comprobar el suministro eléctrico
Temperatura errónea	Conexión de cables incorrecta	Comprobar los códigos de color de los cables
Temperatura errónea	Cable sensor defectuoso	Confirmar la continuidad de los cables
Temperatura errónea	Obstrucción del campo visual	Retirar obstrucción

LIMPIEZA DE LA LENTE

Mantener la lente limpia en todo momento. Cualquier materia extraña en la lente afectaría la precisión de medición. Soplar las partículas sueltas (si no se usa el accesorio de purga de aire) con un 'soplador' de aire.

GARANTÍA

Calnex garantiza que cada instrumento que fabrica no presentará defectos de material ni de mano de obra bajo circunstancias de uso y servicio normales por un período de dos años desde la fecha de compra. Esta garantía se extiende solamente al comprador original, según los términos y condiciones de venta de Calnex.

Nei sensori pirometrici non a contatto serie PyroMini la sonda di misura della temperatura è di dimensioni molto ridotte ed è collegata a distanza alla sua centralina elettronica separata.

Per tutti i modelli si può regolare l'emissività nell'elettronica separata. Così si può misurare la temperatura di svariati materiali e prodotti come: alimentari, carta, tessuti, plastiche, tabacco, pellame, prodotti farmaceutici e chimici, carbone, asfalto, ecc.

Le centraline elettroniche con tasti a sfioro consentono l'indicazione della temperatura, la configurazione della sonda, allarmi a relè, la funzione di Data Logger con la scheda MicroSD secondo le varie versioni. La sonda può essere fornita per elevata temperatura ambiente fino a 180°C. In tale esecuzione il cavo schermato progettato per le alte temperature è anche resistente ai disturbi elettrici. E' quindi ideale per applicazione su oggetti in movimento, come per esempio sul braccio dei robot.

Ampia scelta di ottiche per misure su piccoli o grandi oggetti, a lunghe o ridotte distanze. Possibilità di avere uscite da contatti di relè, uscita analogica 4-20 mA e RS485 Modbus.

DATI TECNICI

GENERALI

Gamma temperature	Vedi la tabella Sigle dei Modelli
Max intervallo di temperatura (modelli CRT)	1020°C
Min intervallo di temperatura (modelli CRT)	100°C
Uscita	Da 4 a 20 mA o RS485 Modbus
Risoluzione ottica	Vedi la tabella Sigle dei Modelli
Precisione	±1% della lettura o ±1°C al massimo
Ripetibilità	±0.5% della lettura o ±0.5°C al massimo
Gamma impostabile di emissività	Da 0.20 a 1.00
Modo di impostare l'emissività	Modelli CB: con due selettori rotativi interni alla centralina Modelli BB e BRT: via RS485 Modelli CRT e BRT: con i tasti sullo schermo
Tempo di risposta	240ms (90% di risposta)
Banda spettrale	da 8 a 14µm
Alimentazione	24Vcc ±5%
Massimo consumo di corrente	100 mA
Massima impedenza del loop	Per i modelli CB e CRT: 900 Ω (uscita 4-20 mA)
Relè di allarme (modelli CRT)	2 Relè in commutazione. 24 Vcc/1 A max. sui contatti, tensione di isolamento: 500Vcc

SPECIFICHE MECCANICHE

	Sensore	Electronica separata
Materiale	Acciaio AISI 316	Fusione di Alluminio
Dimensioni di ingombro	Ø18 x 45 mm	98(L) x 54(H) x 36(P)mm
Montaggio	M16 x 1 mm filettato	Due viti M4 per montaggio a parete (vedi disegni pag 12)

Lunghezza del cavo (dalla sonda alla centralina)	1 m (standard), fino a 30 m (opzionale)
Peso con 1 m di cavo	390 g (circa)
Connessione dei cavi	Terminali accessibili rimuovendo le 4 viti del coperchio (vedi pag 12). Sezioni dei cavi: da 28 a 18 AWG
Manicotto passacavo	Per cavi di diametro da 3.0 a 6.5 mm

DATI TECNICI AMBIENTALI

	Sonda	Centralina senza schermo	Centralina con schermo
Grado di protezione	IP65 (NEMA 4)	IP65 (NEMA 4)	-
Temperatura operativa	Vedi per ogni modello i valori di pag.4	da 0°C a 60°C	da 0°C a 60°C
Umidità relativa	Massimo 95% senza condensa	Massimo 95% senza condensa	Massimo 95% senza condensa
Marcatura CE	Si	Si	Si
Conformità al RoHS	Si	Si	Si

STANDARD DI COMPATIBILITA' ELETTROMAGNETICA:

Classe	Standard	Descrizione
Direttiva EMC	EN61326-1:2006	Apparecchiature elettriche di misura e di controllo per industria e laboratorio
Immunità	IEC 61000-4-2	Immunità a scariche elettrostatiche
	IEC 61000-4-3	Immunità a campi elettromagnetici
	IEC 61000-4-4	Immunità allo scoppio
	IEC 61000-4-5	Immunità a picchi di tensione
	IEC 61000-4-6	Immunità a RF indotta
Emissioni	EN 55022A	Emissioni RF Classe A
	EN 55022B	Emissioni RF Classe B

SIGLE DEI MODELLI

I sensori PyroMini possono essere forniti nelle seguenti combinazioni relativamente alla temperatura operativa, alla risoluzione ottica, alla gamma della temperatura misurata, alle uscite e alle interfacce :

Serie	Temperatura operativa della sonda	Risoluzione ottica	Gamma di misura della temperatura	Uscite ed interfacce
PM	MA	21 151 301 CF	LT MT HT XT	CB
			CT	CRT BB BRT
	HA	201	HT XT	CB
			CT	CRT BB BRT

TEMPERATURA OPERATIVA DELLA SONDA

- MA** da 0°C a 60°C
- HA** da 0°C a 180°C

La sonda HA impiegata in ambienti con elevate temperature resiste fino a 180°C senza l'impiego di elementi aggiuntivi di raffreddamento. Viene fornita con ottica di risoluzione 20:1.

La sonda HA mantiene quindi le sue dimensioni ridotte in ambienti molto caldi senza dovere impiegare ingombranti camicie di raffreddamento.

DIAGRAMMI DELLA RISOLUZIONE OTTICA

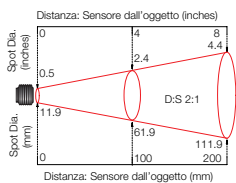

-21

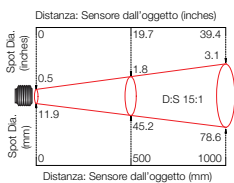

-151

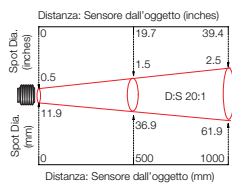

-201

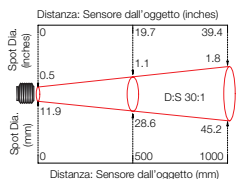

-301

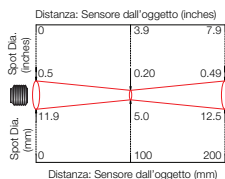

-CF

Il diametro dello spot rispetto alla distanza dalla testa della sonda è dato per il 90% dell'energia termica

SCALE DI MISURA DELLA TEMPERATURA (°C)

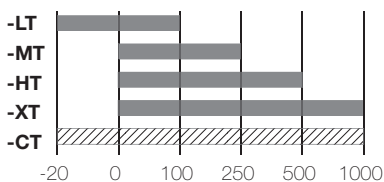

- Prefissata. Es. per MT <scala da 0°C (4mA) a 250°C (20mA)
- ▨ Modelli CRT: uscita 4-20mA configurabile in tutta la gamma
- Modelli BT e BB: uscita digitale su tutta la gamma

USCITA E SCHERMO

- CB** uscita 4-20 mA , senza schermo
- CRT** uscita 4-20 mA e due allarmi a relè con schermo a sfioro
- BB** uscita RS485 Modbus , senza schermo
- BRT** uscita RS485 Modbus e due allarmi a relè, con schermo a sfioro

ESEMPIO: PM-MA-301-CT-BRT

Serie	Temperatura operativa della sonda	Risoluzione ottica	Gamma di misura della temperatura	Uscite ed interfacce
PM PyroMini	-MA da 0°C a 60°C	-301 30:1 divergente	-CT Configurabile in tutta la gamma da -20°C a 1000°C	-BRT uscita RS485 Modbus e due allarmi a relè, con schermo a sfioro

REGOLAZIONE DELLA EMISSIVITA' (MODELLI – CB)

Sui modelli PyroMini -CB l'emissività può essere regolata per mezzo di due selettori rotativi che si trovano all'interno della centralina. Per regolare l'emissività procedere come segue:

Selezionare con il selettore di sinistra la prima cifra dopo il punto decimale (0.1).

Selezionare con il selettore di destra la seconda cifra dopo il punto decimale(0.01).

Per selezionare l'emissività 1.00 posizionare entrambi i selettori nella posizione 0.

Il minimo valore di emissività selezionabile è 0.2. Se si seleziona un valore inferiore a 0.2 il sensore va in default al valore 0.95.

Per esempio:

Selettore di sinistra	Selettore di destra	Emissività impostata
6	3	0.63
0	0	1.00

SCHERMO CON TASTI A SFIORO (MODELLI –CRT E -BRT)



Lo schermo con i tasti a sfioro montato sul coperchio della centralina (opzionale, a seconda dei modelli) consente una chiara visualizzazione della temperatura misurata così come le opzioni per la completa configurazione del sensore. I grafici riportano l'andamento nel tempo della temperatura rilevata.

Nelle condizioni di allarme lo schermo cambia colore per dare una immediata percezione visiva dell'allarme. In tali condizioni le modalità e i livelli di allarme sono configurati con i tasti che appaiono sullo schermo.



DATI TECNICI DELLO SCHERMO

Display dello schermo	2.83" (72 mm), contatto resistivo TFT, 320 x 240 pixel, retroilluminato
Parametri configurabili	gamma,e unità delle temperature, valore di emissività, compensazione dell'energia riflessa,allarmi, valori del processo, indirizzo Modbus (modelli -BRT), data e tempo, data-logger.
Unità di temperatura	°C o °F, selezionabili
Risoluzione	0.1°C
Configurazione allarmi	Due livelli regolabili di allarme, configurabili singolarmente come HI (alto) o LO (basso). L'allarme 2 può essere selezionato come temperatura del target o come quella interna dalla sonda.
Valori del Processo	Selezionabili: Media, Valori di picco e di valle, MIN, MAX.



DESCRIZIONE DELLO SCHERMO

<p>Icone in default</p>	<p>Letture delle temperature Cifre molto visibili della temperatura misurata e lettura facilitata dello schermo grazie alle icone. Lo sfondo nero diventa rosso quando è attivato un allarme.</p>
<p>Selezione in gradi °C e °F</p> <p>Selezione della temperatura</p>  	<p>Le unità di misura sono selezionate direttamente sullo schermo. Premere su " °C " per selezionare i gradi °F e viceversa.</p> <p>Premete sulla cifra della temperatura per selezionare il tipo di lettura visualizzata</p> <p>Temperatura filtrata Temperatura misurata con la media e la funzione di mantenimento. Questa temperatura è quella dell'uscita del sensore 4-20 mA per le versioni –CB e –CRT.</p> <p>Temperatura media Temperatura misurata nella media ma senza il mantenimento</p> <p>Temperatura non filtrata Temperatura misurata senza la funzione di mantenimento (vedi a pag.8 "Uscite del processo"). Visualizzazione della icona della scheda MicroSD</p> <p>Questa icona appare quando è inserita la scheda SD e lampeggia quando il Data Logger è in funzione.</p> <p>Questa icona appare quando viene abilitata la programmata raccolta dei dati ma questa deve ancora iniziare.</p>



	<p>Elenco delle letture Visualizza l'elenco delle temperature misurate, dello stato degli allarmi e lo stato della acquisizione dati (Data Logger).</p>
	<p>Temperatura filtrata: temperatura misurata, con temperatura media e con funzione di mantenimento.</p> <p>Temperatura non filtrata : temperatura reale del processo</p> <p>Temperatura media : la media delle temperature rilevate nel periodo prefissato (vedi a pag. 8 "Uscite del processo").</p> <p>Temperatura massima : la massima temperatura rilevata durante il periodo di mantenimento, come media.</p> <p>Temperatura minima : la temperatura più bassa rilevata durante il periodo di mantenimento, come media.</p> <p>Temperatura del sensore : temperatura interna della sonda.</p> <p>Temperatura riflessa : temperatura compensata dalla energia riflessa, come specificato a pag.9 "Emissività e compensazione (Emissivity and Compensation)".</p>

 	<p>Password di sicurezza Codice numerico di 4 cifre per prevenire la manomissione dei valori impostati. La posizione di blocco impedisce nuove programmazioni.</p> <p>La password di default è 1234.</p>
	<p>Cambio di password Digitare, confermare e salvare un nuovo codice a quattro cifre.</p>

 	<p>Start/Stop della acquisizione dei dati Avviamento manuale della raccolta dei dati (GO), premendo "STOP" la si ferma. E' necessario inserire la scheda MicroSD, fornibile separatamente.</p> <p>Se si sono già impostati il giorno e l'ora di attivazione del Data Logger non si può fare partire manualmente l'acquisizione dei dati.</p> <p>Per farlo partire manualmente bisogna prima disabilitare i dati impostati.</p>
--	---

	<p>Grafici Registrono l'andamento recente della temperatura dell'oggetto misurato e quella interna della sonda. Per valutare il tempo di misura precedente toccare lo schermo e spostare il dito. Memoria delle ultime 24 ore di dati.</p>
 	<p>Azzeramento dei grafici Premere il tasto "Clear" per cancellare il grafico.</p> <p>Grafico in tempo reale Premendo il pulsante ritorna la visualizzazione del grafico con l'andamento delle misure recenti.</p>

	<p>Riconoscimento degli allarmi Commutare le uscite dei relè dagli allarmi impostati allo stato normale senza soglia di azionamento. Lo sfondo dello schermo rimarrà rosso e gli allarmi non entreranno in azione fino a che non vengono impostati di nuovo. (Vedi sezione "Allarmi" a pag 9 e 10). Gli allarmi possono essere riconosciuti anche con display bloccato.</p>
---	--

	<p>Programmazione Accesso alla configurazione dei parametri. Premere il pulsante  - per salvare il programma, o premere  per uscire e lasciare la schermata senza salvataggio.</p>
---	---

SELEZIONE DEI PROGRAMMI



Data e ora

Impostare data e ora ai fini dell'acquisizione dati. (con scheda MicroSD). L'orologio è disattivato fino a che non viene inserita la batteria nel suo apposito alloggiamento sotto il coperchio dello schermo.



Elaborazione di uscita

Questa schermata, come tutte le altre di questa sezione, la si imposta facilmente premendo i pulsanti riportanti i simboli rappresentati nella colonna di sinistra.

Periodo di media

Selezionare il tempo in secondi entro il quale si ha l'indicazione della media delle temperature misurate in tale intervallo. Questa modalità serve soprattutto quando le temperature cambiano molto velocemente. Minimo tempo: 0 sec (niente misura media), massimo:60 sec.

Modalità di mantenimento

Temperatura di picco

Il sensore mantiene il valore massimo di temperatura raggiunto nel periodo programmato. Nel periodo successivo se il sensore rileva un valore più alto di temperatura lo mantiene per tutto il periodo.

Temperatura di valle

Similmente a quanto sopra detto il sensore mantiene per tutto il periodo il valore minimo della temperatura misurata.

Disabilitazione

Il mantenimento dei valori sopra riportati viene disabilitato.

Periodo di mantenimento

Per le funzioni di mantenimento si deve preselezionare l'intervallo di tempo voluto: da 0 (esclusione della funzione) al massimo di 1200 sec.



Acquisizione dei dati

Questa funzione viene installata tramite la scheda MicroSD e la batteria nel retro del coperchio contenete lo schermo come è descritto nel paragrafo "Installazione.." di pag.12.

Periodo di campionatura

Tempo in secondi tra due sequenze di campionatura. Minimo un sec. massimo 86400 sec (un giorno).

Numero di campionature

Il numero di sequenze di campionatura prima della fine della raccolta dati. Minimo: 0 (raccolta continua), massimo 86400 che rappresenta un giorno di dati raccolti se il periodo di campionamento è di 1 secondo.

Abilitazione dello start

Il sensore inizia la raccolta dei dati al giorno e all'ora programmate. Il data-logger può essere fatto partire e fermato anche manualmente.

Data e ora



Data e ora dell'inizio della acquisizione dei dati.

SELEZIONE DEI PROGRAMMI



	Emissività e Compensazione
Impostazione della emissività	Rilevare l'emissività dell'oggetto da misurare. Ciò può essere fatto in via sperimentale o confrontando una tabella riportante i dati di emissività dei vari materiali (Contattare Calex). Valore minimo 0.2 max. 1.0
Compensazione della energia riflessa	Se abilitata, compensa gli errori causati dalla energia riflessa da oggetti più caldi o più freddi posti nelle vicinanze della sonda.
Temperatura riflessa	il valore della temperatura riflessa degli oggetti vicini al target. Minima: -20°C, massima: 1000°C.

	Uscita 4-20 mA (per modelli -CRT) Selezionare i limiti della gamma di temperatura per l'uscita 4 e 20 mA
Temperatura a 4 mA	Limite della temperatura inferiore. Minima: - 20°C. Massima: 900°C
Temperatura a 20 mA	Limite della temperatura superiore. Minima 80°C. Massima 1000°C
Nota importante	La differenza tra le temperature a 20 mA e a 4 mA non deve essere inferiore a 100 °C. La temperatura a 20 mA deve essere maggiore di quella a 4 mA.

	Indirizzi Modbus (per modelli -BRT)
Indirizzo Modbus	L'indirizzo corrente del Modbus è visualizzato sullo schermo. Per cambiarlo inserire il nuovo numero e premeril tasto "Apply" per salvarlo sul sensore. Numeri disponibili da 1 a 247 massimo.

	Allarmi Configurazione separata degli allarmi 1 e 2 e impostazione degli stessi anche nel Data Logger, se previsto
	Reset degli allarmi Se è stato impostato un allarme, entrambi gli allarmi possono essere nuovamente impostati. Gli allarmi non potranno più scattare fino a che si resettano in modalità manuale o automatica.

PROGRAMMAZIONE DEGLI ALLARMI

	Allarme 1 e Allarme 2
Impostazione del set-point Isteresi Temperatura filtrata o temperatura della sonda (solo allarme 2) Tipo di allarme Azzeramento	<p>Temperatura alla quale scatta l'allarme (set-point). Minimo -20°C, Massimo 1000°C.</p> <p>La differenza di temperatura tra quella impostata come set-point e quella di reset dell'allarme. L'isteresi è usata solo nella modalità di reset automatico. (Vedi diagramma alla pagina successiva). Minimo: 0°C (isteresi disabilitata). Massimo: 1000°C.</p> <p>Selezionare la temperatura dell'allarme 2. (Allarme 2 solo per la temperatura della sonda. Per monitorare lo stato della temperatura ambiente in cui è posta la sonda).</p> <p>Alto L'allarme si attiva quando la temperatura è salita fino al set-point. Basso L'allarme è attivato quando la temperatura è scesa fino al set-point. Allarme escluso L'allarme è disattivato.</p> <p>Automatico L'allarme è riconosciuto al raggiungimento della temperatura di set-point. e si ripristina alla temperatura di reset (vedi isteresi). Può anche essere impostato e resettato manualmente. Manuale L'allarme si attiva premendo l'icona "acknowledge"  nella schermata delle temperature o degli elenchi e resettato premendo  nella schermata degli allarmi.</p>

	Allarmi della acquisizione dati Eventi di allarme possono essere inseriti nella scheda MicroSD. Questi sono indipendenti dagli allarmi descritti nella sezione precedente.
Ora di scatto dell'allarme Allarme come start del Data Logger Riconoscimento dell'allarme Reset dell'allarme	<p>Viene memorizzata l'ora in cui l'allarme viene attivato .</p> <p>La raccolta dei dati inizia quando un allarme viene attivato. Viene raccolta una campionatura ogni secondo. La raccolta dei dati si ferma quando entrambi gli allarmi sono resettati.</p> <p>Viene memorizzata l'ora in cui l'allarme viene riconosciuto .</p> <p>Viene memorizzata l'ora in cui l'allarme viene resettato.</p>

ISTERESI SUGLI ALLARMI E RESET AUTOMATICO

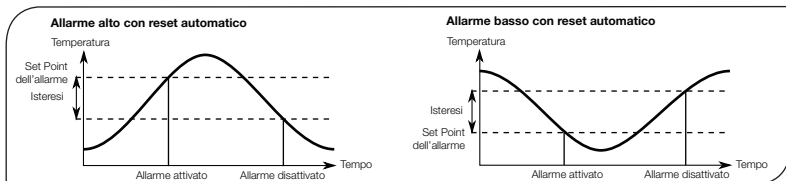

RACCOLTA DEI DATI (MODELLI -CRT E BRT)

Il PyroMini può essere usato come Data Logger stazionario.

I modelli PyroMini -CRT and -BRT contengono una sede per l'inserimento della scheda MicroSD per la raccolta dei dati, che può essere configurata con i tasti sullo schermo. Si può selezionare il tempo di campionatura e il numero di campionature ed impostare il tempo di start della raccolta dati. Con la scheda a 2 GB, l'utilizzatore può memorizzare 28.4 milioni di letture, che rappresentano almeno 1 anno di raccolta dati al più veloce tempo di campionatura possibile e cioè di 1 al secondo.

I dati sono immagazzinati nella scheda MicroSD nel formato .csv e possono essere visti o modificati facilmente con qualsiasi tipo di software.







La scheda MicroSD viene fornita separatamente come accessorio con il suo adattatore..

Le sedi per l'alloggiamento della scheda MicroSD e della batteria sono sotto il coperchio contenente lo schermo. La lettura dell'ora e del giorno è data da un orologio elettronico interno che senza la batteria inserita si azzerava quando si toglie tensione all'apparecchiatura, mentre continua a batteria inserita.

DATI TECNICI DELLA RACCOLTA DEI DATI

Intervallo di lettura:	da 1 a 86,400 secondi (1 giorno)
Max. Capacità della MicroSD:	2 GB (non inclusa)
Batteria per l'orologio interno:	1 x BR 1225 3V (non incluso)
Parametri registrati:	Temperatura dell'oggetto, temperature della sonda, temperature centralina, T max, min, media, selezione emissività, compensazione energia riflessa.
Formato del file:	.csv
Parametri configurabili:	Periodo di campionamento, numero di campionamenti, start giorno e ora.
Gamma indirizzi Modbus:	da 1 a 247

UTILIZZO DEL PYROMINI COME DATA LOGGER

- Inserire la scheda MicroSD nel suo alloggiamento sul circuito stampato sotto il coperchio.
- Per mantenere i dati quando il PyroMini è disconnesso, inserire la batteria nella sua sede nel circuito stampato sotto il coperchio come si vede nella foto di pag. 68.
- Rimettere il coperchio con le sue viti e collegare il sensore alla alimentazione.
- Selezionare il numero delle campionature da effettuare, il periodo di tempo tra due campionature, e se richiesto, impostare la raccolta dati con start automatico premendo  per accedere al menù principale, quindi premendo  - si accede alle varie opzioni.
- Per salvare i programmi impostati premere .
- Per far partire manualmente la raccolta dati, premere  sulle videate della temperatura o degli elenchi.
- Mentre è in funzione la raccolta dati, la relativa icona  lampeggia su Temperature ed Elenchi.
- Per fermare la raccolta dati, premere .
- Per trasferire su un PC i dati raccolti, rimuovere la scheda MicroSD dalla sua sede, inserire la scheda nell'adattatore fornito con la scheda (accessorio modello MSD) e riporla in un lettore di schede SD.

Nota: le schede MicroSDHC non sono compatibili con i PyroMini.

INSTALLAZIONE DELLA SCHEDA MICROSD E DELLA BATTERIA

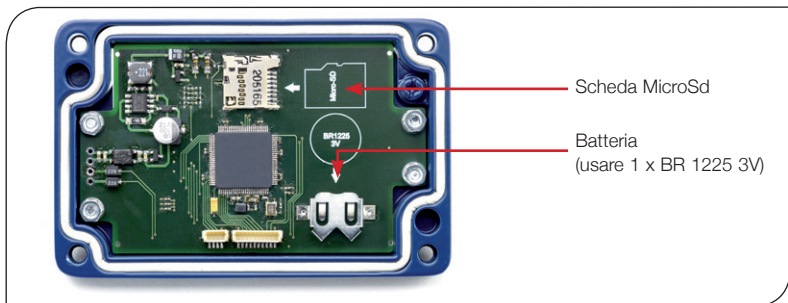

FILES DELLA ACQUISIZIONE DATI

I dati salvati nella scheda MicroSD hanno il formato .csv. I file di questo formato possono essere aperti o importati da fogli di calcolo software, come per esempio Microsoft Excel.

Viene creata una nuova cartella nella scheda MicroSD Card per ogni giorno in cui i dati sono stati raccolti.

Un nuovo file viene creato ogni qual volta il data logger viene messo in funzione. Il file viene nominato con la data di inizio della acquisizione dei dati.

DIMENSIONI

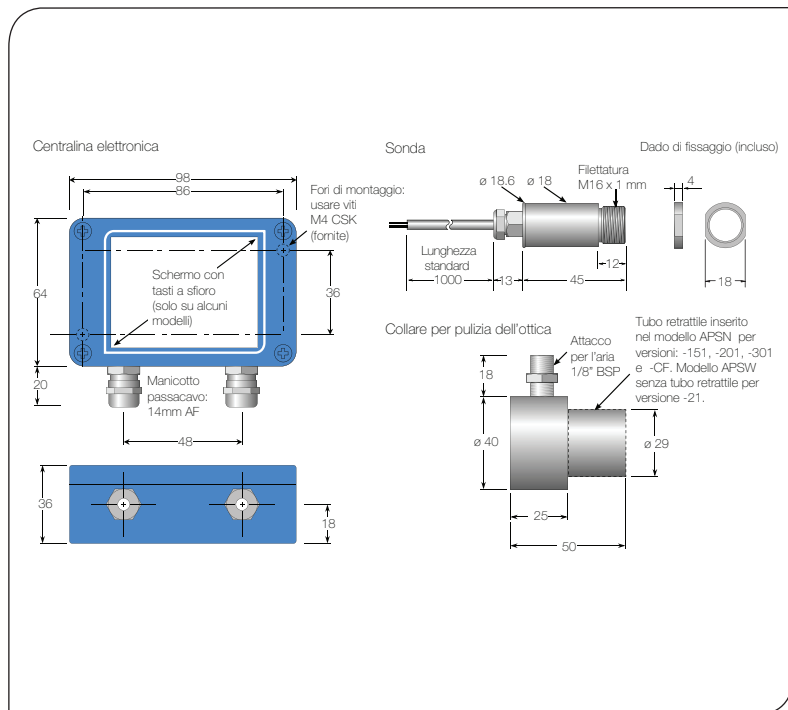

Squadretta di montaggio fissa (FBS)

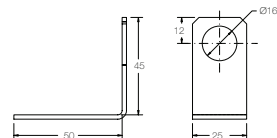

2x fori di fissaggio M4

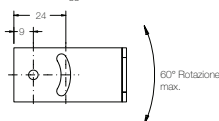

Squadretta di montaggio regolabile (ABS)

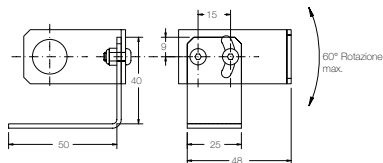

2x fori di fissaggio M4

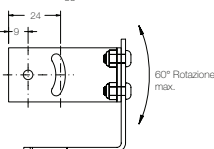

ACCESSORI

Sono disponibili diversi accessori adatti a differenti applicazioni nel settore industriale. Questi accessori possono essere acquistati anche successivamente e applicati dal cliente in campo. Calnex può fornire:

Squadretta di montaggio fissa FBS (vedi sopra le dimensioni). Consente regolazione del sensore solo sul piano orizzontale per spostamenti di 60°.

Squadretta di montaggio regolabile ABS (vedi sopra le dimensioni) consente la regolazione sul piano orizzontale e verticale per spostamenti di 60°.

Collare per la pulizia dell'ottica (vedi fig. pagina precedente). Insufflato con aria compressa consente di tenere l'ottica pulita da sporco, fumi, umidità e altri fattori che possono contaminare la lente. Deve essere avvitato completamente entro la sonda. L'aria viene fatta entrare nel manicotto 1/8" BPS e fuoriesce dalla apertura frontale. E' raccomandata aria pulita per strumentazione con una portata da 5 a 15 l/min.

Il modello **APSW** è utilizzabile con la sonda di ottica 2:1. Il modello **APSN** per tutte le altre ottiche.

Laser di allineamento LSTS. Installato sulla sonda durante il montaggio o il riallineamento questo laser a luce visibile e puntiforme permette di visualizzare il centro dell'oggetto da misurare.

Scheda MicroSD modello MSD. Serve per immagazzinare i dati raccolti. Si usa con i piometri modello -BRT e -CRT. Questo accessorio include anche l'adattatore per inserire la scheda nel PC.

OPZIONI

Sono fornibili le seguenti opzioni. Le opzioni devono essere installate in fabbrica sul sensore e quindi devono essere specificate all'ordine:

Certificato di calibrazione CALCERTA: certificato rintracciabile secondo la metodologia UKAS che riporta tre punti di temperatura misurati nella scala di misura del sensore.

Estensione del cavo (fino ad una lunghezza massima di 30 m). Il sensore standard viene fornito con un cavo lungo un metro. Cavi di lunghezza maggiori possono essere forniti montati sul sensore con incrementi di 1 m. Ci sono due modelli: **PMCE** per la sonda standard -MA, modello **PMCEHT** per la versione ad alta temperatura -HA (cavo blindato). Vedi pag. seguente.

INSTALLAZIONE

Il processo di installazione consiste nelle seguenti fasi:

Preparazione

Installazione meccanica

Installazione elettrica

Si prega di leggere interamente le seguenti sezioni prima di procedere all'installazione.

PREPARAZIONE

Assicurarsi che il sensore pirometrico sia posizionato in modo di essere focalizzato sull'oggetto di cui si deve misurare la temperatura

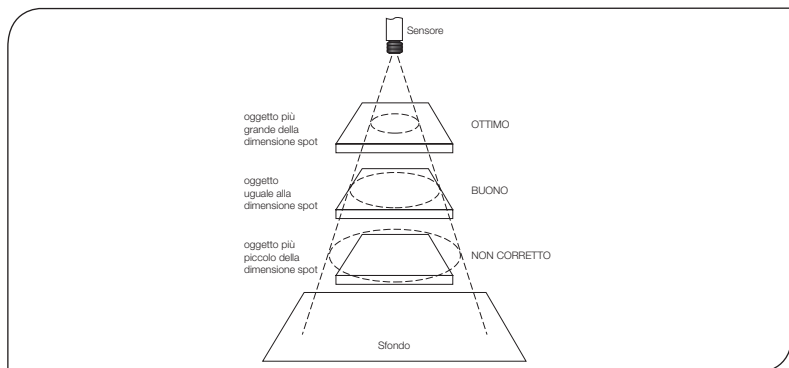

DISTANZA E DIMENSIONE SPOT

In base al cono utile (spot) che parte dal sensore (vedi disegno sopra riportato) la dimensione dell'area da misurare determina la distanza tra sensore e oggetto. L'oggetto non deve essere più grande dello spot, in questo caso si deve allontanare il sensore all'oggetto fino che lo stesso risulta uguale o più piccolo dello spot.

TEMPERATURA AMBIENTE

I pirometri PyroMini possono essere forniti con due tipi di sonde: una per funzionamento in ambienti con temperature normali e un'altra per temperature ambiente elevate.

Modello -MA: la sonda può operare con temperatura ambiente da 0°C a 60°C.

Modello -HA: la sonda è stata progettata per funzionare con temperatura da 0°C fino a 180°C.

Con questo ultimo tipo di sonda non è richiesto un ulteriore sistema di raffreddamento risparmiando così energia e costi dei fluidi di raffreddamento del sensore come acqua o aria.

Evitare shock termici. Aspettare circa 20 minuti per adeguare il sensore pirometrico alla temperatura dell'ambiente.

QUALITA' ATMOSFERICA

Se nell'ambiente l'aria è impregnata di fumo o di impurità usare il collare di raffreddamento per pulire l'ottica del sensore.

INTERFERENZE CAUSATE DAL MOVIMENTO

Il cavo montato sulla testa della sonda -HA è resistente ai disturbi elettrici incontrati nel movimento della sonda. Per cui questa sonda può essere montata su una parte in movimento della macchina come per esempio sul braccio di un robot senza che il suo movimento riduca la precisione nella misura della temperatura.

INTERFERENZE ELETTRICHE

I PyroMini sono testati in conformità agli standard industriali della compatibilità elettromagnetica (EMC) come descritto nelle specifiche.

Per evitare interferenze e disturbi causati dai campi elettromagnetici posizionare il sensore lontano da motori, cavi di alta tensione, ecc.

ALIMENTAZIONE

Controllare che l'alimentazione sia 24 Vcc (100 mA)

INSTALLAZIONE MECCANICA

I sensori sono forniti con cavo di 1 m e dado di fissaggio, sono fornibili cavi più lunghi, da stabilire all'ordine. Per il montaggio sulla parte terminale filettata tramite squadrette fisse o regolabili come quelle fornibili dalla casa o di proprio disegno.

NOTA BENE: Il sensore deve essere messo a terra solo su un punto: o sul cavo schermato o dal contenitore del sensore. Per evitare ritorni a terra, assicurarsi che il sensore sia collegato a terra solo in uno di questi punti.

INSTALLAZIONE ELETTRICA

Modelli CB e CRT:

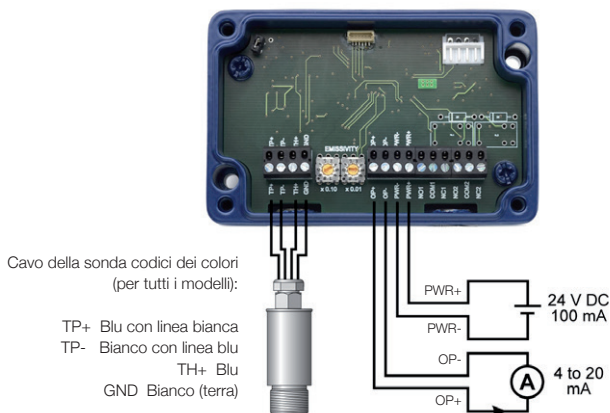

Modelli BB e BRT:

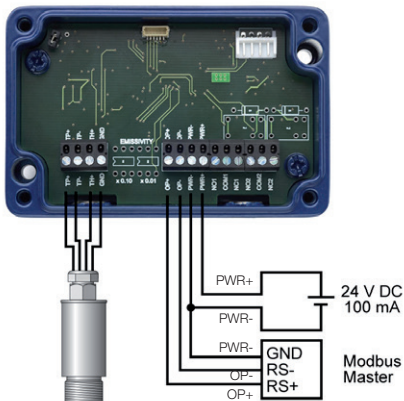

CABLAGGIO (PER TUTTI I MODELLI)

Per prima cosa verificare le distanze tra sonda e centralina e tra centralina e la strumentazione a valle. Se necessario ordinare la sonda con un cavo della lunghezza richiesta per poterla collegare comodamente alla sua centralina.

I cavi che escono dalla centralina dovrebbero avere un diametro compreso tra 3,0 e 6.5 mm con conduttori terminali di dimensione da 28 a 18 AWG. I blocchetti di connessione posti sul circuito stampato della centralina sono estraibili per facilitare il cablaggio all'operatore.

Non disconnettere il circuito stampato posto sotto lo schermo dal circuito stampato principale mentre il sensore è alimentato.

CABLAGGIO DEI MODELLI -BB E -BRT

Quando diversi sensori vengono connessi ad una rete Modbus, tutti i sensori dovrebbero essere connessi al singolo cavo del bus di rete tramite una scatola di connessione. Il cavo del bus corre dal sensore più lontano al Modbus Master.

Ad una singola rete Modbus possono essere connessi fino a 247 sensori. Ogni sensore deve avere un proprio indirizzo Modbus. I PyroMini sono normalmente forniti con l'indirizzo modbus 1. Gli indirizzi Modbus possono essere cambiati sul modello -BRT con l'interfaccia dello schermo oppure via Modbus.

Per prevenire interferenze o disturbi dei dati, assicurarsi che il cavo di congiunzione tra il sensore e la rete principale sia il più corto possibile. Il bus di campo dovrebbe terminare con una resistenza di 120 Ω posta tra i fili RS+ e RS- Il filo PWR del bus dovrebbe essere connesso al segnale di terra del Modbus Master.

MODBUS SU LINEA SERIALE

INTERFACCIA

Velocità di trasmissione	9600 Baud
Formato	8 bit di dati, no bit di parità, 1 bit di stop
Tempo di risposta	20 ms

FUNZIONI SUPPORTATE

Registro di lettura	0x03, 0x04
Registro di scrittura singola	0x06
Registro di scrittura multipla	0x10
Registro di scrittura maschera	0x16
Letture/scrittura	0x17

La tabella sottostante include tutti gli indirizzi utilizzabili:

R = Lettura , W = Scrittura (singola, multipla o lettura/scrittura), MW = Scrittura maschera

Indirizzo	Lunghezza (parole)	Descrizione	R/W/MW
0x00	1	Indirizzo di slave MODBUS (da 1 a 247)	R/W*
0x02	2	Registro di identificazione del sensore Bit da 0 a 19 – Numeri di serie Bit da 20 a 23 – Tipo di sensore (12 = PyroMini) Bit da 24 a 36 – Risoluzione ottica Modelli MA : 0 = 2:1, 1 = 15:1, 2 = 30:1 Modelli HA: 0 = 20:1 Bit da 27..32 – Riservati	R

Indirizzo	Lunghezza (parole)	Descrizione	R/W/MW
0x06	1	Temperatura non filtrata dell'oggetto	R
0x08	1	Temperatura del sensore	R
0x0A	1	Temperatura massima nel periodo considerato	R
0x0C	1	Temperatura minima nel periodo considerato	R
0x0E	1	Temperatura media nel periodo considerato	R
0x10	1	Temperatura filtrata dell'oggetto	R
0x12	1	Temperatura del circuito stampato	R
0x14	1	Impostazione Emissività (1 LSB = 0,0001) Minimo: 0,2000, Massimo: 1,0000	R/W
0x16	1	Temperatura riflessa	R/W
0x18	1	Registro dello stato del sensore Bit da 0 a 1 – Riservati Bit 2 – Mantenimento del processo ON (1) /OFF (0) Bit 3 – Picchi del periodo considerato (1) /Valori minimi (0) Bit da 4 a 6 – Riservati Bit 7 – Compensazione dell'energia riflessa ON (1) / OFF (0) Bit da 8 a 15 – Riservati	R/W/MW
0x1A	1	Impostazione del periodo di media (1 LSB = 0,05 secondi) Minimo: 0,05 secondi, Massimo: 60,00 secondi	R/W
0x1C	1	Periodo di mantenimento (1 LSB = 0,05 secondi) Minimo: 0,05 secondi, Massimo: 60,00 secondi	R/W
0x1E	1	Temperatura a 4 mA Minima -20°C, Massima 900°C	R/W
0x20	1	Temperatura a 20 mA Minima 80°C, Massima 1000°C	R/W
0x22	1	Setpoint allarme 1 Minimo -20°C, Massimo 1000°C	R/W
0x24	1	Isteresi allarme 1 Minima 0°C, Massima 1000°C	R/W
0x26	1	Allarme 1 - Registro degli stati Bit 0 – Relè impostato (R) Bit 1 – Allarme visivo attivo (R) Bit 2 – Allarme impostato (R) Bit 3 – Reset Auto(1)/Reset manuale (0) (R/W/MW) Bit 4 – Riconoscimento dell'allarme (R/W/MW) Bit 5 – Reset dell'allarme (R/W/MW) Bits 6..7 – Riservati Bit 8 – Allarme alto (1)/allarme basso (0) (R/W/MW) Bit 9 – Allarme abilitato (1)/disabilitato (0) Bits 10..15 – Riservati	R/W/MW

Indirizzo	Lunghezza (parole)	Descrizione	R/W/MW
0x28	1	Allarme 2 - Registro degli stati Bit 0 – Relè impostato (R) Bit 1 – Allarme visivo attivo (R) Bit 2 – Allarme impostato (R) Bit 3 – Reset Auto (1)/Reset manual (0) (R/W/MW) Bit 4 – Riconoscimento dell'allarme (R/W/MW) Bit 5 – Reset dell'allarme (R/W/MW) Bit 6 – Riservato Bit 7 – Temperatura filtrata dell'oggetto (1)/temperatura della sonda (0) (R/W/MW) Bit 8 – Allarme alto (1)/allarme basso (0) (R/W/MW) Bit 9 – Allarme abilitato (1)/disabilitato (0) Bits 10..15 – Riservati	R/W/MW
0x2A	1	Setpoint dell'allarme 2 Minimo -20°C, Massimo 1000°C	R/W
0x2C	1	Isteresi dell'allarme 2 Minimo 0°C, Massimo 1000°C	R/W

* Singolo registro di sola lettura. Il nuovo indirizzo non entra in funzione fino alla riaccensione successiva

Note:

1. Tutte le temperature sono espresse in decimi di grado °C
2. Scrivere su bit indicati come riservati o senza registrazione può causare malfunzionamenti
3. Tutte le parole e le operazioni di maschera sono salvate in una memoria non volatile
4. Per eventuali ulteriori informazioni consultate <http://www.modbus.org/specs.php>
5. Usare l'indirizzo 255 per comunicare con ogni sensore connesso. Usare l'indirizzo 0 per trasmettere verso tutti i sensori collegati (non aspettarsi alcuna risposta)

FUNZIONAMENTO

Installato il sensore e collegato alla rete elettrica ed eventualmente ai circuiti di raffreddamento, si procede a:

1. Dare tensione al sensore
2. Collegare alla rete la strumentazione associata
3. Leggere, controllare o inviare i dati della temperatura.

AVVERTENZE

- Se la temperatura ambiente varia in modo significativo, attendere circa 20 minuti per il tempo di stabilizzazione necessario per avere misure affidabili
- Non azionare il sensore in prossimità di consistenti campi elettromagnetici (p.e. vicino ad archi voltaici o forni a induzione). I disturbi elettromagnetici possono causare errori rilevanti della misura
- Accertarsi in anticipo che i cablaggi elettrici siano fatti sui terminali giusti.

RILEVAMENTO ATTRAVERSO UNA FINESTRA

I sensori PyroMini sono in grado di misurare la temperatura di un bersaglio attraverso una speciale finestra fatta in un materiale che trasmette le radiazioni infrarosse da 8 a 14 micron. In questo caso bisogna regolare di nuovo l'emissività per compensare le variazioni date dalla finestra. Usando un sensore PyroMini con questa finestra interpellare Calex per ulteriori suggerimenti.

MANUTENZIONE

Salvo che per una periodica pulizia dell'ottica il sensore non richiede una particolare manutenzione. In caso di cattivo funzionamento chiedere all'agente locale consigli per l'eliminazione del problema avvalendosi della sottostante tabella diagnostica. Solo in caso di non risolvere il problema dopo questo contatto rimandare il sensore alla Casa o all'agente locale per un più approfondito controllo.

Identificazione dei problemi		
Problema	Causa probabile	Soluzione
Manca l'uscita	Sensore non alimentato	Controllo alimentazione
Misura non corretta	Fili mal collegati	Controllo colore del filo
Misura non corretta	Cavo sensore difettoso	Verifica continuità del cavo
Misura non corretta	Ostruzione campo visivo	Rimuovere ostruzione

PULIZIA DELL'OTTICA

Mantenere la lente sempre pulita. Depositi sulla lente influenzano la misura. Se il sensore non è dotato del collare di pulizia e vi sono particelle solide usare un getto di aria o un panno bagnato d'acqua non contenente abrasivi.

GARANZIA

Calex garantisce i suoi prodotti per la durata di due anni dalla consegna. Questa garanzia vale solo per il cliente originale secondo i termini usuali delle condizioni di vendita.